



# Chapter 2 Part B:

## General engine overhaul procedures

### Contents

Compression check	3	Engine overhaul - general information	2
Crankshaft - inspection	19	Engine overhaul - reassembly sequence	21
Crankshaft - refitting and main bearing oil clearance check	24	Engine removal - methods and precautions	4
Crankshaft - removal	13	General information	1
Crankshaft rear oil seal - refitting	25	Initial start-up and break-in after overhaul	27
Cylinder head and components - cleaning and inspection	9	Intermediate shaft - refitting	23
Cylinder head - dismantling	8	Intermediate shaft - removal and inspection	14
Cylinder head - reassembly	11	Main and connecting big-end bearings - inspection	20
Cylinder honing	17	Piston rings - refitting	22
Engine - removal and refitting	5	Pistons/connecting rods - inspection	18
Engine block - cleaning	15	Pistons/connecting rods - refitting and big-end bearing oil clearance check	26
Engine block - inspection	16	Pistons/connecting rods - removal	12
Engine overhaul - alternatives	6	Valves - servicing	10
Engine overhaul - dismantling sequence	7		

### Degrees of difficulty

<b>Easy</b> , suitable for novice with little experience 	<b>Fairly easy</b> , suitable for beginner with some experience 	<b>Fairly difficult</b> , suitable for competent DIY mechanic 	<b>Difficult</b> , suitable for experienced DIY mechanic 	<b>Very difficult</b> , suitable for expert DIY or professional 
---	--	--	---	--

### Specifications

#### General

Cylinder compression pressure (all engines)	10 to 11 bars
Oil pressure (all engines)	
At idle	0.5 to 2.0 bars
Running (for example, at 4000 rpm)	4 bars or above (typically)
Cylinder head warpage limit	
Except M40 engine	0.10 mm
M40 engine	0.03 mm
Minimum cylinder head thickness (do not resurface the head to a thickness less than listed)	
M10 and M30 engines	128.6 mm
M20 engines	124.7 mm
M40 engine	140.55 mm

#### Valves

Valve stem diameter (standard)	
M10 and M30 engines	8.0 mm
M20 engine	7.0 mm
M40 engine	
Intake	6.975 mm
Exhaust	6.960 mm
Minimum valve margin width	
Intake	1.191 mm
Exhaust	1.98 mm
Valve stem maximum lateral movement (see text)	0.787 mm
Valve face angle	
Intake	45°
Exhaust	45°

## 2B•2 General engine overhaul procedures

### Camshaft and rocker arms

Camshaft bearing oil clearance	0.033 to 0.076 mm
Camshaft endfloat	
M10 engine	0.02 to 0.13 mm
M20 engine	0.2 mm maximum
M30 engine	0.03 to 0.18 mm
M40 engine	0.065 to 0.150 mm
Rocker arm radial clearance	0.015 to 0.051 mm

### Crankshaft

Endfloat	
M10 and M30 engines	0.085 to 0.174 mm
M20 and M40 engines	0.080 to 0.163 mm
Main bearing journal diameter (standard)	
M10 engines	
Red classification	54.98 to 54.99 mm
Blue classification	54.97 to 54.98 mm
M20 engines	
Red classification	59.98 to 59.99 mm
Blue classification	59.97 to 59.98 mm
M30 and M40 engines	
Yellow classification	59.984 to 59.990 mm
Green classification	59.977 to 59.983 mm
White classification	59.971 to 59.976 mm
Main bearing journal diameter undersizes	
1st undersize	0.25 mm
2nd undersize	0.50 mm
3rd undersize (where applicable)	0.75 mm
Main bearing oil clearance	
M10 and M20 engines	0.030 to 0.070 mm
M30 and M40 engines	0.020 to 0.046 mm
Connecting rod journal diameter (standard)	
M10 and M30 engines	47.975 to 47.991 mm
M20 and M40 engines	44.975 to 44.991 mm
Connecting rod journal diameter undersizes	
1st undersize	0.25 mm
2nd undersize	0.50 mm
3rd undersize (where applicable)	0.75 mm

### Connecting rods

Connecting rod side play (all engines)	0.041 mm
Connecting big-end bearing oil clearance	
M10 engines	0.030 to 0.070 mm
M20 and M30 engines	0.020 to 0.055 mm
M40 engines	0.010 to 0.052 mm

### Engine block

Cylinder bore - diameter (standard)	
M10/B18 engine	89.00 to 89.01 mm
M20/B20 engine	80.00 to 80.01 mm
M20/B25 engine	84.00 to 84.01 mm
M30/B25 engine	86.00 to 86.01 mm
M30/B28 engine	86.00 to 86.01 mm
M30/B30M engine	89.00 to 89.01 mm
M30/B34 engine	92.00 to 92.01 mm
M30/B35M engine	92.00 to 92.01 mm
M40/B16 engine	84.000 to 84.014 mm
M40/B18 engine	84.000 to 84.014 mm
Cylinder out-of-round limit (maximum)	
M20/B20 engine	0.02 mm
M20/B25 engine	0.03 mm
All other engines	0.01 mm
Cylinder taper (maximum)	
M20/B20 and M20/B25 engines	0.02 mm
All other engines	0.01 mm

**Pistons and piston rings**

Piston diameter (standard)	
M10 engines	88.97 mm
M20 engines	
B20	79.98 mm
B25	83.98 mm
M30 engines	
B30M	
Alcan	88.970 mm
KS	88.980 mm
B35M	
Alcan	91.972 mm
Mahle	91.980 mm
M40 engines	
Factory stage 0	83.985 mm
Factory stage 00	84.065 mm
Piston-to-cylinder wall clearance	
New	
M10 and M30 engines	0.02 to 0.05 mm
M20 and M40 engines	0.01 to 0.04 mm
Service limit	
Except B25 engine	0.15 mm
B25 engine	0.12 mm
Piston ring end gap	
M10 engine	
Top compression ring	0.30 to 0.70 mm
Second compression ring	0.20 to 0.40 mm
Oil ring	0.25 to 0.50 mm
M20 engine	
All rings	0.20 to 0.50 mm
M30 engine	
Top compression ring	0.20 to 0.45 mm
Second compression ring	0.40 to 0.65 mm
Oil ring	0.30 to 0.60 mm
M40 engine	
Top compression ring	0.20 to 1.00 mm
Second compression ring	0.20 to 1.00 mm
Oil ring	
B16 engine	0.20 to 1.00 mm
B18 engine	0.40 to 1.40 mm
Piston ring side clearance	
M10 engine	
Top compression ring	0.06 to 0.09 mm
Second compression ring	0.03 to 0.072 mm
Oil ring	0.02 to 0.06 mm
M20 engine	
Top compression ring	0.04 to 0.08 mm
Second compression ring	0.03 to 0.07 mm
Oil ring	0.02 to 0.05 mm
M30 engine	
Top compression ring	0.04 to 0.072 mm
Second compression ring	0.03 to 0.062 mm
Oil ring	0.02 to 0.055 mm
M40 engine	
Top compression ring	0.02 to 0.20 mm
Second compression ring	0.02 to 0.10 mm
Oil ring	
B16 engine	0.02 to 0.10 mm
B18 engine	Not measured

**Torque wrench settings****Nm**

Main bearing cap-to-engine block bolts\*

M10, M20 and M30 engines	60
M40 engines	
Stage 1	20
Stage 2	Angle-tighten an additional 50°

Torque wrench settings (continued)	Nm
Connecting rod cap bolts/nuts	
M10 and M30 engines	55
M20 and M40 engines	
Stage 1	20
Stage 2	Angle-tighten an additional 70°
Camshaft bearing caps (M40 engine)	10
Intermediate shaft sprocket-to-shaft bolt (M20 engine)	60
Oil supply tube bolt(s)	
M6 (normal) and M8 (banjo)	10
M5	5

\* BMW recommend that the main bearing bolts are renewed as a matter of course.

## 1 General information

Included in this Part of Chapter 2 are the general overhaul procedures for the cylinder head and engine internal components.

The information ranges from advice concerning preparation for an overhaul and the purchase of new parts to detailed, paragraph-by-paragraph procedures covering removal and refitting of internal components and the inspection of parts.

The following Sections have been written based on the assumption that the engine has been removed from the vehicle. For information concerning in-vehicle engine repair, as well as removal and refitting of the external components necessary for the overhaul, see Chapter 2A, and Section 7 of this Part.

The Specifications included in this Part are only those necessary for the inspection and overhaul procedures which follow. Refer to Part A for additional Specifications.

## 2 Engine overhaul - general information

It's not always easy to determine when, or if, an engine should be completely overhauled, as a number of factors must be considered.

High mileage is not necessarily an indication that an overhaul is needed, while low mileage doesn't preclude the need for an overhaul. Frequency of servicing is probably the most important consideration. An engine that's had regular and frequent oil and filter changes, as well as other required maintenance, will most likely give many thousands of miles of reliable service. Conversely, a neglected engine may require an overhaul very early in its life.

Excessive oil consumption is an indication that piston rings, valve seals and/or valve guides are in need of attention. Make sure that oil leaks aren't responsible before deciding that the rings and/or guides are worn. Perform a cylinder compression check to determine the extent of the work required (see Section 3).

Check the oil pressure: Unscrew the oil pressure sender unit, and connect an oil pressure gauge in its place. Measure the oil pressure with the engine at its normal operating temperature. Compare your readings to the oil pressures listed in this Chapter's Specifications. If the readings are significantly below these (and if the oil and oil filter are in good condition), the crankshaft bearings and/or the oil pump are probably worn out. On M10 and M30 engines, the oil pressure sender unit is located high on the left rear of the cylinder head. On M20 engines, the sender unit is threaded into the side of the engine block, below the oil filter. On M40 engines, the sender unit is threaded into the rear of the oil filter housing.

Loss of power, rough running, knocking or metallic engine noises, excessive valve train noise and high fuel consumption may also point to the need for an overhaul, especially if they're all present at the same time. If a complete tune-up doesn't remedy the situation, major mechanical work is the only solution.

An engine overhaul involves restoring the internal parts to the specifications of a new engine. During an overhaul, new piston rings are fitted and the cylinder walls are reconditioned (rebored and/or honed). If a rebores is done by an engineering works, new oversize pistons will also be fitted. The main bearings and connecting big-end bearings are generally renewed and, if necessary, the crankshaft may be reground to restore the journals. Generally, the valves are serviced as well, since they're usually in less-than-perfect condition at this point. While the engine is being overhauled, other components, such as the distributor, starter and alternator, can be rebuilt as well. The end result should be a like-new engine that will give many thousands of trouble-free miles. **Note:** *Critical cooling system components such as the hoses, drivebelts, thermostat and water pump MUST be renewed when an engine is overhauled. The radiator should be checked carefully, to ensure that it isn't clogged or leaking (see Chapters 1 or 3). Also, we don't recommend overhauling the oil pump - always fit a new one when an engine is rebuilt.*

Before beginning the engine overhaul, read through the entire procedure to familiarise yourself with the scope and requirements of

the job. Overhauling an engine isn't difficult if you follow all of the instructions carefully, have the necessary tools and equipment and pay close attention to all specifications; however, it is time consuming. Plan on the vehicle being tied up for a minimum of two weeks, especially if parts must be taken to an automotive machine shop for repair or reconditioning. Check on availability of parts and make sure that any necessary special tools and equipment are obtained in advance. Most work can be done with typical hand tools, although a number of precision measuring tools are required for inspecting parts to determine if they must be replaced. Often an automotive machine shop will handle the inspection of parts and offer advice concerning reconditioning and renewal. **Note:** *Always wait until the engine has been completely disassembled and all components, especially the engine block, have been inspected before deciding what service and repair operations must be performed by an automotive machine shop. Since the block's condition will be the major factor to consider when determining whether to overhaul the original engine or buy a rebuilt one, never purchase parts or have machine work done on other components until the block has been thoroughly inspected. As a general rule, time is the primary cost of an overhaul, so it doesn't pay to refit worn or substandard parts.*

As a final note, to ensure maximum life and minimum trouble from a rebuilt engine, everything must be assembled with care, in a spotlessly-clean environment.

## 3 Compression check



**1** A compression check will tell you what mechanical condition the upper end (pistons, rings, valves, head gaskets) of your engine is in. Specifically, it can tell you if the compression is down due to leakage caused by worn piston rings, defective valves and seats, or a blown head gasket. **Note:** *The engine must be at normal operating temperature, and the battery must be fully-charged, for this check.*

**2** Begin by cleaning the area around the spark plugs before you remove them (compressed air should be used, if available,



**3.5** As a safety precaution, before performing a compression check, remove the cover and the main relay (arrowed) from the left side of the engine compartment to disable the fuel and ignition systems (525i model shown, other models similar)

otherwise a small brush or even a bicycle tyre pump will work). The idea is to prevent dirt from getting into the cylinders as the compression check is being done.

**3** Remove all the spark plugs from the engine (see Chapter 1).

**4** Block the throttle wide open, or have an assistant hold the throttle pedal down.

**5** On carburettor models, disconnect the LT lead from the coil. On fuel injection models, disable the fuel pump and ignition circuit by removing the main relay (see illustration). This is to avoid the possibility of a fire from fuel being sprayed in the engine compartment. The location of the main relay is generally near the fuse panel area under the bonnet, but refer to Chapter 12 for the specific location on your model.

**6** Fit the compression gauge in the No 1 spark plug hole (No 1 cylinder is nearest the radiator).

**7** Turn the engine on the starter motor over at least seven compression strokes, and watch the gauge. The compression should build up quickly in a healthy engine. Low compression on the first stroke, followed by gradually-increasing pressure on successive strokes, indicates worn piston rings. A low compression reading on the first stroke, which doesn't build up during successive strokes, indicates leaking valves or a blown head gasket (a cracked head could also be the cause). Deposits on the undersides of the valve heads can also cause low compression. Record the highest gauge reading obtained.

**8** Repeat the procedure for the remaining cylinders, and compare the results to the compression listed in this Chapter's Specifications.

**9** If compression was low, add some engine oil (about three squirts from a plunger-type oil can) to each cylinder, through the spark plug hole, and repeat the test.

**10** If the compression increases after the oil is added, the piston rings are definitely worn. If the compression doesn't increase

significantly, the leakage is occurring at the valves or head gasket. Leakage past the valves may be caused by burned valve seats and/or faces or warped, cracked or bent valves.

**11** If two adjacent cylinders have equally low compression, there's a strong possibility that the head gasket between them is blown. The appearance of coolant in the combustion chambers or the crankcase would verify this condition.

**12** If one cylinder is 20 percent lower than the others, and the engine has a slightly rough idle, a worn exhaust lobe on the camshaft could be the cause.

**13** If the compression is unusually high, the combustion chambers are probably coated with carbon deposits. If that's the case, the cylinder head should be removed and decarbonised.

**14** If compression is way down, or varies greatly between cylinders, it would be a good idea to have a leak-down test performed by a garage. This test will pinpoint exactly where the leakage is occurring and how severe it is.

#### 4 Engine removal - methods and precautions

If you've decided that an engine must be removed for overhaul or major repair work, several preliminary steps should be taken.

Locating a suitable place to work is extremely important. Adequate work space, along with storage space for the vehicle, will be needed. If a workshop or garage isn't available, at the very least a flat, level, clean work surface made of concrete or asphalt is required.

Cleaning the engine compartment and engine before beginning the removal procedure will help keep tools clean and organised.

An engine hoist or A-frame will also be necessary. Make sure the equipment is rated in excess of the combined weight of the engine and accessories. Safety is of primary importance, considering the potential hazards involved in lifting the engine out of the vehicle.

If the engine is being removed by a novice, a helper should be available. Advice and aid from someone more experienced would also be helpful. There are many instances when one person cannot simultaneously perform all of the operations required when lifting the engine out of the vehicle.

Plan the operation ahead of time. Arrange for or obtain all the tools and equipment you'll need prior to beginning the job. Some of the equipment necessary to perform engine removal and refitting safely and with relative ease are (in addition to an engine hoist) a heavy-duty trolley jack, complete sets of spanners and sockets as described in the

front of this manual, wooden blocks, and plenty of rags and cleaning solvent for mopping up spilled oil, coolant and fuel. If the hoist must be hired, make sure that you arrange for it in advance, and perform all of the operations possible without it beforehand. This will save you money and time.

Plan for the vehicle to be out of use for quite a while. A machine shop will be required to perform some of the work which the do-it-yourselfer can't accomplish without special equipment. These establishments often have a busy schedule, so it would be a good idea to consult them before removing the engine, in order to accurately estimate the amount of time required to rebuild or repair components that may need work.

Always be extremely careful when removing and refitting the engine. Serious injury can result from careless actions. Plan ahead, take your time and a job of this nature, although major, can be accomplished successfully.

**Warning:** The air conditioning system is under high pressure. Do not loosen any fittings or remove any components until after the system has been discharged by a qualified engineer. Always wear eye protection when disconnecting air conditioning system fittings.



**Caution:** If removing the M40 engine, it is important not to turn the engine upside-down for longer than 10 minutes since it is possible for the oil to drain out of the hydraulic tappets. This would render the tappets unserviceable, and damage could possibly occur to the engine when it is next started up.



#### 5 Engine - removal and refitting

**Caution:** If the radio in your vehicle is equipped with an anti-theft system, make sure you have the correct activation code before disconnecting the battery.

**Note:** If, after connecting the battery, the wrong language appears on the instrument panel display, refer to page 0-7 for the language resetting procedure.

##### Removal

**1** Relieve the fuel system pressure (see Chapter 4), then disconnect the negative cable from the battery.

**2** Cover the wings and front panel, and remove the bonnet (see Chapter 11). Special pads are available to protect the wings, but an old bedspread or blanket will also work.

**3** Remove the air cleaner housing and intake ducts (see Chapter 4).

**4** Drain the cooling system (see Chapter 1).

**5** Label the vacuum lines, emissions system hoses, wiring connectors, earth straps and fuel lines, to ensure correct refitting, then

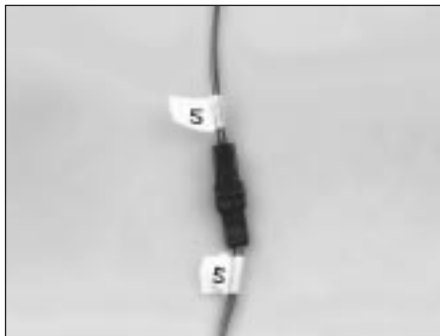

5.5 Label each wire before unplugging the connector

detach them. Pieces of masking tape with numbers or letters written on them work well (see illustration).



**If there's any possibility of confusion, make a sketch of the engine compartment and clearly label the lines, hoses and wires.**

6 Label and detach all coolant hoses from the engine (see Chapter 3).

7 Remove the cooling fan, shroud and radiator (see Chapter 3). **Note:** *On the M40 engine, it is only necessary to remove the cooling fan and shroud; however, prevent damage to the radiator by covering it with a piece of wood or cardboard.*

8 Remove the drivebelts (see Chapter 1).

9 Disconnect the fuel lines from the fuel rail (see Chapter 4).



**Warning: Fuel is extremely flammable, so take extra precautions when you work on any part of the fuel system. Don't smoke, or allow open flames or bare light bulbs, near the work area, and don't work in a garage where a natural gas-type appliance (such as a water heater or clothes dryer) with a pilot light is present. If you spill any fuel on your skin, rinse it off immediately with soap and water. When you perform any kind of work on the fuel system, wear safety glasses, and have a fire extinguisher on hand.**

10 Disconnect the accelerator cable (see Chapter 4) and kickdown linkage/speed control cable (see Chapter 7B), if applicable, from the engine.

11 Where fitted, unbolt the power steering pump (see Chapter 10). Leave the lines/hoses attached, and make sure the pump is kept in an upright position in the engine compartment (use wire or rope to restrain it out of the way).

12 On air-conditioned models, unbolt the compressor (see Chapter 3) and set it aside, or tie it up out of the way. **Do not** disconnect the hoses.

13 Drain the engine oil (see Chapter 1) and remove the filter. Remove the engine splash guard from under the engine.

14 Remove the starter motor (see Chapter 5).

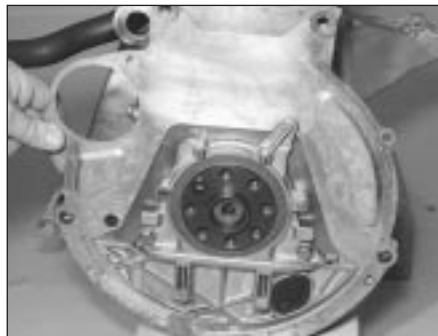

5.26 Removing the engine rear plate - M40 engine

15 Remove the alternator (see Chapter 5). This is not essential on all models, but it is a good idea in any case to avoid accidental damage.

16 Unbolt the exhaust system from the engine (see Chapter 4).

17 If you're working on a vehicle with an automatic transmission, remove the torque converter-to-driveplate fasteners (see Chapter 7B). On the M40 engine, unbolt the automatic transmission fluid coolant pipes from the sump.

18 Support the transmission with a jack. Position a block of wood between them, to prevent damage to the transmission. Special transmission jacks with safety chains are available - use one if possible.

19 Attach an engine sling or a length of chain to the lifting brackets on the engine. If the brackets have been removed, the chain can be bolted directly to the intake manifold studs, but place a flat washer between the chain and the nut, and tighten the nut all the way up to the chain, to avoid the possibility of the studs bending.

20 Roll the hoist into position and connect the sling to it. Take up the slack in the sling or chain, but don't lift the engine.



**Warning: DO NOT place any part of your body under the engine when it's supported only by a hoist or other lifting device.**

21 On M10, M20 and M30 engines, remove the transmission rear crossmember, and slightly lower the rear of the transmission.

22 Remove the transmission-to-engine block bolts using a Torx socket. **Note:** *The bolts holding the bellhousing to the engine block will require a swivel at the socket, and a very long extension going back towards the transmission.*

23 Remove the engine mounting-to-frame bracket nuts. On the M40 engine, unbolt the dampers from the mountings.

24 Recheck to be sure nothing is still connecting the engine to the transmission or vehicle. Disconnect anything still remaining.

25 Raise the engine slightly. Carefully work it forwards to separate it from the transmission. If you're working on a vehicle with an automatic transmission, you may find the torque converter comes forward with the

engine. If it stays with the transmission, leave it, but you may find it easier to let it come forward until it can be grasped easier and be pulled from the crankshaft. **Note:** *When refitting the torque converter to the transmission before the engine is refitted, be sure to renew the transmission front pump seal, which will probably be damaged when the converter comes out with the engine.* Either method is acceptable, but be prepared for some fluid to leak from the torque converter if it comes out of the transmission. If you're working on a vehicle with a manual transmission, draw the engine forwards until the input shaft is completely disengaged from the clutch. Slowly raise the engine out of the engine compartment. Check carefully to make sure everything is disconnected.

26 Remove the flywheel/driveplate (and where applicable, the engine rear plate), and mount the engine on an engine stand (see illustration). Do not turn the M40 engine upside-down (see **Caution** in Section 4).

### Refitting

27 Check the engine and transmission mountings. If they're worn or damaged, renew them.

28 Refit the flywheel or driveplate (see Chapter 2A). If you're working on a manual transmission vehicle, refit the clutch and pressure plate (see Chapter 7A). Now is a good time to fit a new clutch.

29 If the torque converter came out with the engine during removal, carefully refit the converter into the transmission before the engine is lowered into the vehicle.

30 Carefully lower the engine into the engine compartment - make sure the engine mountings line up.

31 If you're working on an automatic transmission vehicle, guide the torque converter onto the crankshaft following the procedure outlined in Chapter 7B.

32 If you're working on a manual transmission vehicle, apply a dab of high-melting-point grease to the input shaft, and guide it into the clutch and crankshaft pilot bearing until the bellhousing is flush with the engine block. Do not allow the weight of the engine to hang on the input shaft.



**It may be necessary to rock the engine slightly, or to turn the crankshaft, to allow the input shaft splines to mate with the clutch plate**

33 Refit the transmission-to-engine bolts, and tighten them securely.



**Caution: DO NOT use the bolts to force the transmission and engine together.**

34 Refit the remaining components in the reverse order of removal.

35 Add coolant, oil, power steering and transmission fluid as needed.

36 Run the engine and check for leaks and proper operation of all accessories, then refit the bonnet and test drive the vehicle.

37 Where necessary, have the air conditioning system recharged and leak-tested.

## 6 Engine overhaul - alternatives

The do-it-yourselfer is faced with a number of options when performing an engine overhaul. The decision to renew the engine block, piston/connecting rod assemblies and crankshaft depends on a number of factors, with the number one consideration being the condition of the block. Other considerations are cost, access to machine shop facilities, parts availability, time required to complete the project, and the extent of prior mechanical experience on the part of the do-it-yourselfer.

Some of the alternatives include:

**Individual parts** - If the inspection procedures reveal that the engine block and most engine components are in re-usable condition, purchasing individual parts may be the most economical alternative. The block, crankshaft and piston/connecting rod assemblies should all be inspected carefully. Even if the block shows little wear, the cylinder bores should be surface-honed.

**Crankshaft kit** - A crankshaft kit (where available) consists of a reground crankshaft with matched undersize new main and connecting big-end bearings. Sometimes, reconditioned connecting rods and new pistons and rings are included with the kit (such a kit is sometimes called an "engine kit"). If the block is in good condition, but the crankshaft journals are scored or worn, a crankshaft kit and other individual parts may be the most economical alternative.

**Short block** - A short block consists of an engine block with a crankshaft and piston/connecting rod assemblies already fitted. New bearings are fitted, and all clearances will be correct. The existing camshaft, valve train components, cylinder head and external parts can be bolted to the short block with little or no machine shop work necessary.

**Full block** - A "full" or "complete" block consists of a short block plus an oil pump, sump, cylinder head, valve cover, camshaft and valve train components, timing sprockets and chain (or belt) and timing cover. All components are fitted with new bearings, seals and gaskets used throughout. The refitting of manifolds and external parts is all that's necessary.

Give careful thought to which alternative is best for you, and discuss the situation with local machine shops, parts dealers and experienced rebuilders before ordering or purchasing new parts.

## 7 Engine overhaul - dismantling sequence

1 It's much easier to dismantle and work on the engine if it's mounted on a portable engine stand. A stand can often be hired quite cheaply from a tool hire shop. Before the engine is mounted on a stand, the flywheel/driveplate should be removed from the engine.

2 If a stand isn't available, it's possible to dismantle the engine with it blocked up on the floor. Be extra-careful not to tip or drop the engine when working without a stand.

3 If you're going to obtain a rebuilt engine, all the external components listed below must come off first, to be transferred to the new engine if applicable. This is also the case if you're doing a complete engine overhaul yourself. **Note:** When removing the external components from the engine, pay close attention to details that may be helpful or important during refitting. Note the fitted position of gaskets, seals, spacers, pins, brackets, washers, bolts and other small items.

*Alternator and brackets*

*Emissions control components*

*Distributor, HT leads and spark plugs*

*Thermostat and housing cover*

*Water pump*

*Fuel injection/carburettor and fuel system components*

*Intake and exhaust manifolds*

*Oil filter and oil pressure sending unit*

*Engine mounting brackets (see illustration)*

*Clutch and flywheel/driveplate*

*Engine rear plate (where applicable)*

4 If you're obtaining a short block, which consists of the engine block, crankshaft, pistons and connecting rods all assembled, then the cylinder head, sump and oil pump will have to be removed as well. See Section 6 for additional information regarding the different possibilities to be considered.

5 If you're planning a complete overhaul, the engine must be dismantled and the internal components removed in the following general order:

*Valve cover*

*Intake and exhaust manifolds*

*Timing belt or chain covers*

*Timing chain/belt*

*Water pump*

*Cylinder head*

*Sump*

*Oil pump*

*Piston/connecting rod assemblies*

*Crankshaft and main bearings*

*Camshaft*

*Rocker shafts and rocker arms (M10, M20 and M30 engines)*

*Cam followers and hydraulic tappets (M40 engine)*

*Valve spring retainers and springs*

*Valves*

6 Before beginning the dismantling and



7.3 Engine left-hand mounting bracket - M40 engine

overhaul procedures, make sure the following items are available. Also, refer to Section 21 for a list of tools and materials needed for engine reassembly.

*Common hand tools*

*Small cardboard boxes or plastic bags for storing parts*

*Compartment-type metal box for storing the hydraulic tappets (M40 engine)*

*Gasket scraper*

*Ridge reamer*

*Vibration damper puller*

*Micrometers*

*Telescoping gauges*

*Dial indicator set*

*Valve spring compressor*

*Cylinder surfacing hone*

*Piston ring groove cleaning tool*

*Electric drill motor*

*Tap and die set*

*Wire brushes*

*Oil gallery brushes*

*Cleaning solvent*

## 8 Cylinder head - dismantling



1 Remove the cylinder head (see Chapter 2A).  
2 Remove the oil supply tube from its mounting on top of the cylinder head (see illustrations). **Note:** It's important to renew the seals under the tube mounting bolts.

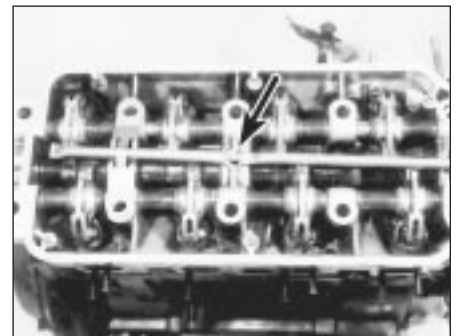

8.2a Remove the oil tube from the top of the cylinder head (M10 engine). Be sure to note the location of all gaskets and washers for reassembly

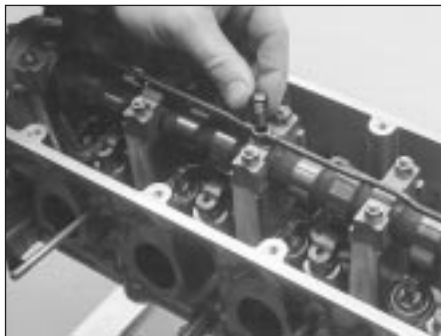

8.2b Removing the oil tube from the camshaft bearing caps on the top of the cylinder head (M40 engine)

### M10, M20 and M30 engines

3 Adjust all valves to their maximum clearance by rotating the eccentric on the valve end of the rocker arm towards the centre of the head (see Chapter 1, if necessary).

4 Before removing the thrustplate, measure the camshaft endfloat by mounting a dial indicator to the front end of the cylinder head, with the probe resting on the camshaft (see illustration). Prise the camshaft back-and-forth in the cylinder head. The reading is the camshaft endfloat. Compare the reading to this Chapter's Specifications.

5 Unbolt and remove the camshaft thrustplate. **Note:** There are two different locations for the thrustplate. On M10 and M30 engines, it is attached on the front of the cylinder head, behind the timing gear flange. On M20 and M40 engines, the thrustplate is located inside the head, by the rocker shafts, at the forward end of the cylinder head.

6 Remove the rear cover plate from the back of the cylinder head (see illustration).

7 Remove the retaining clips from each of the rocker arms. **Note:** There is more than one style of clip. The wire-type clips (see illustration) are fitted one each side of the rocker arm; the spring-steel-type goes over the rocker arm, and clips onto either side of it.

8 Before removing the rocker arm shafts, measure the rocker arm radial clearance, using a dial indicator, and compare your measurement to the Specifications at the



8.7 Remove the retaining clips from the rocker arms - the wire-type clip is shown here

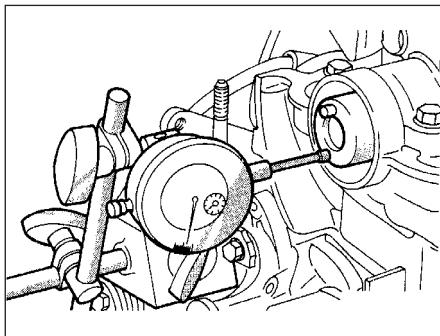

8.4 To check camshaft endfloat, mount a dial indicator so that its stem is in-line with the camshaft and just touching the camshaft at the front

beginning of this Chapter. Without sliding the rocker arm along the shaft, try to rotate the rocker arm against the shaft in each direction (see illustration). The total movement measured at the camshaft end of the rocker arm is the radial clearance. If the clearance is excessive, either the rocker arm bush, rocker arm shaft, or both, will need to be renewed.

9 Remove the rubber retaining plugs, or the threaded plugs, at the front of the cylinder head, as applicable. There is a plug in front of each rocker shaft.



**Caution:** If your engine has welded-in retaining plugs at the front of the rocker shafts, take the cylinder head to a machine shop for plug removal, to avoid possible damage to the cylinder head or the rocker arm shafts.

10 Rotate the camshaft until the most rocker arms possible are loose (not compressing their associated valve springs).

11 For the remaining rocker arms that are still compressing their valve springs, BMW recommends using a special forked tool to compress the rocker arms against the valve springs (and therefore take the valve spring tension off the camshaft lobe). If the tool is not available, insert a standard screwdriver into the gap above the adjuster eccentric at the valve-end tip of each rocker arm. Using the

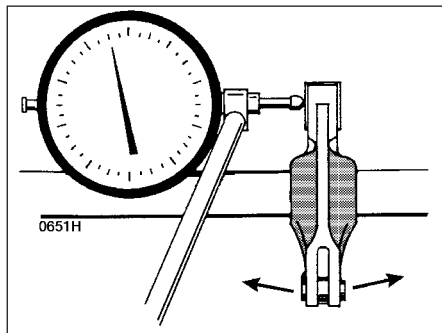

8.8 Check the rocker arm-to-shaft radial clearance by setting up a dial indicator as shown, and trying to rotate the rocker arm against the shaft - DO NOT slide the rocker arm along the shaft



8.6 Remove the cover from the rear of the cylinder head - be sure to note the locations of any washers, gaskets and seals while you are removing the cover

screwdrivers, prise the rocker arms against the valve springs, and hold them in place as the camshaft is removed (see the next paragraph). At least one assistant will be necessary for this operation, since three or four valve springs usually need compressing. If no assistance is available, you could try retaining the screwdrivers that are compressing the valve springs to the bench with lengths of sturdy wire.



**Warning:** Be sure the wire is securely attached to the bench and screwdrivers, or the screwdrivers could fly off the cylinder head, possibly causing injury.

12 When all the rocker arms are no longer contacting the camshaft lobes, slowly and carefully pull the camshaft out the front of the cylinder head. It may be necessary to rotate the camshaft as it is removed.



**Caution:** Be very careful not to scratch the camshaft bearing journals in the cylinder head as the camshaft is withdrawn.

13 After removing the camshaft, carefully remove the rocker arm shafts. On models without threaded holes at the front of the shafts, drive them out from the rear of the cylinder head with a hammer and hardwood dowel that is slightly smaller in diameter than the rocker arm shaft (see illustration). For

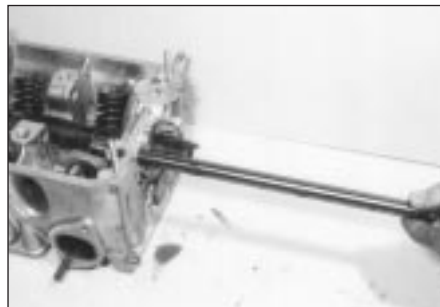

8.13 Removing a rocker arm shaft from the front of the cylinder head - the shaft must be either driven out from the rear of the head with a hardwood dowel or, on models where the rocker shaft is threaded at the front, pulled out from the front with a slide-hammer-type puller



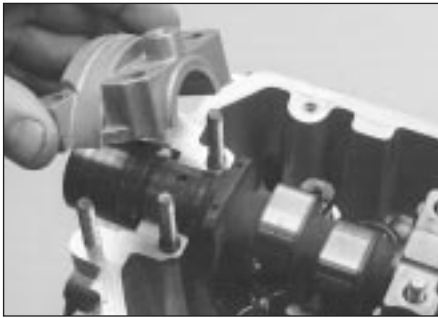

8.17a Removing the camshaft bearing caps . . .

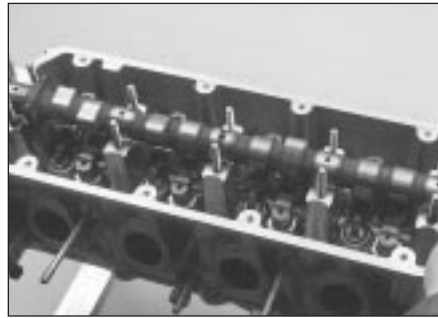

8.17b . . . and camshaft - M40 engine



8.19 Compartmentalised box to hold the hydraulic tappets (M40 engine)

rocker shafts with a threaded front hole, screw in a slide hammer to pull the shaft from the head.

14 As each rocker arm shaft is slid out of the cylinder head, the rocker arms will be released, one by one.

15 Drop each rocker arm into a labelled bag, so they can be returned to their original locations on reassembly. While you're removing the rocker arm shafts, note their orientation. The guide plate notches and the small oil holes face in; the large oil holes face down, toward the valve guides. Also, label the rocker shafts so they can be returned to their original locations in the cylinder head.

#### M40 engines



**Caution:** Keep the cylinder head upright until all of the hydraulic tappets have been removed. If this precaution is not taken, the oil may drain out of the tappets and render them unserviceable.

16 Check that the camshaft bearing caps are numbered or identified for location.

17 Progressively unscrew and remove the camshaft bearing cap retaining bolts, then remove the caps (see illustrations).

18 Lift the camshaft from the top of the cylinder head, and remove the oil seal from the timing end.

19 Have ready a compartmentalised box filled with engine oil to receive the hydraulic tappets so that they are kept identified for their correct location (see illustration). Also have a further box ready to receive the cam followers.



8.20c . . . then lift out the hydraulic tappets

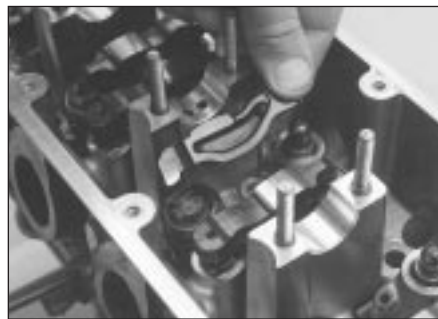

8.20a Remove the cam followers . . .



8.20b . . . and thrust discs . . .

20 Remove the cam followers and thrust discs, then lift out the hydraulic tappets from their bores in the cylinder head (see illustrations).

#### All engines

21 Before the valves are removed, arrange to label and store them, along with their related components, so they can be kept separate and reinstalled in the same valve guides from which they're removed (see illustration).

22 Compress the springs on the first valve with a spring compressor, and remove the collets (see illustration). Carefully release the valve spring compressor, and remove the retainer, the spring and the spring seat (if used).

23 Pull the valve out of the head, then remove the oil seal from the guide.



8.21 A small plastic bag, with an appropriate label, can be used to store the valve components so they can be kept together and refitted in the original position

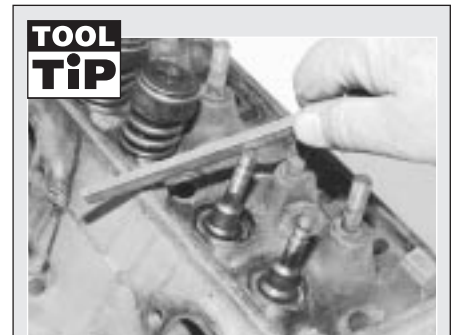

**TOOL TIP**  
*If the valve binds in the guide (won't pull through), push it back into the head, and deburr the area around the collet groove with a fine file or whetstone.*



8.22 Using a valve spring compressor to compress a valve spring

24 Repeat the procedure for the remaining valves. Remember to keep all the parts for each valve together, so they can be refitted in the same locations.

25 Once the valves and related components have been removed and stored in an organised manner, the head should be thoroughly cleaned and inspected. If a complete engine overhaul is being done, finish the engine dismantling procedures before beginning the cylinder head cleaning and inspection process.

## 9 Cylinder head and components - cleaning and inspection



1 Thorough cleaning of the cylinder head(s) and related valve train components, followed by a detailed inspection, will enable you to decide how much valve service work must be done during the engine overhaul. **Note:** If the engine was severely overheated, the cylinder head is probably warped (see paragraph 10).

### Cleaning

2 Scrape all traces of old gasket material and sealing compound off the cylinder head, intake manifold and exhaust manifold sealing surfaces. Be very careful not to gouge the cylinder head. Special gasket removal solvents are available at motor factors.

3 Remove all built-up scale from the coolant passages.

4 Run a stiff brush through the various holes to remove deposits that may have formed in them.

5 Run an appropriate-size tap into each of the threaded holes, to remove corrosion and thread sealant that may be present. If compressed air is available, use it to clear the holes of debris produced by this operation.



**Warning:** Wear eye protection when using compressed air!

6 Clean the cylinder head with solvent, and dry it thoroughly. Compressed air will speed the drying process, and ensure that all holes

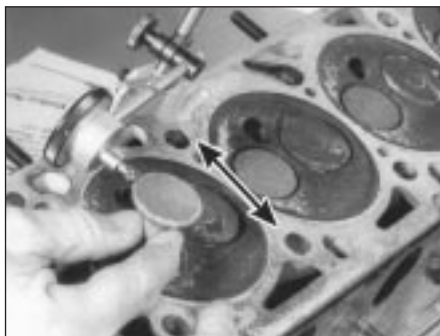

9.12 A dial indicator can be used to determine the valve stem-to-guide clearance (move the valve as indicated by the arrows)

and recessed areas are clean. **Note:** Decarbonising chemicals are available, and may prove very useful when cleaning cylinder heads and valve train components. They are very caustic, however, and should be used with caution. Be sure to follow the instructions on the container.

7 Clean all the rocker shafts/arms/followers, springs, valve springs, spring seats, keepers and retainers with solvent, and dry them thoroughly. Clean the components from one valve at a time, to avoid mixing up the parts.



**Caution:** DO NOT clean the hydraulic tappets of the M40 engine; leave them completely immersed in oil.

8 Scrape off any heavy deposits that may have formed on the valves, then use a motorised wire brush to remove deposits from the valve heads and stems. Again, make sure the valves don't get mixed up.

### Inspection

**Note:** Be sure to perform all of the following inspection procedures before concluding that machine shop work is required. Make a list of the items that need attention.

#### Cylinder head

9 Inspect the head very carefully for cracks, evidence of coolant leakage, and other damage. If cracks are found, check with a machine shop concerning repair. If repair isn't possible, a new cylinder head should be obtained.

10 Using a straightedge and feeler gauge, check the head gasket mating surface for warpage (see illustration). If the warpage exceeds the limit listed in this Chapter's Specifications, it may be possible to have it resurfaced at a machine shop, providing the head is not reduced to less than the specified minimum thickness.

11 Examine the valve seats in each of the combustion chambers. If they're badly pitted, cracked or burned, the head will require servicing that's beyond the scope of the home mechanic.

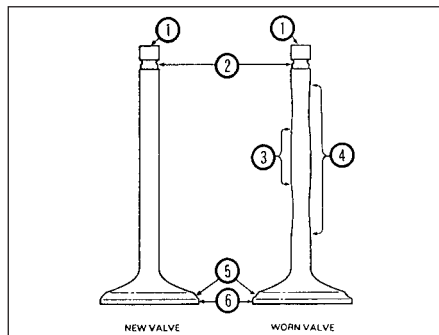

9.13 Check for valve wear at the points shown here

- |                          |                         |
|--------------------------|-------------------------|
| 1 Valve tip              | 4 Stem (most-worn area) |
| 2 Collet groove          | 5 Valve face            |
| 3 Stem (least-worn area) | 6 Margin                |

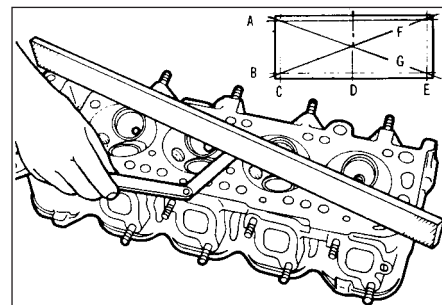

9.10 Check the cylinder head gasket surface for warpage by trying to slip a feeler gauge under the straightedge (see this Chapter's Specifications for the maximum warpage allowed, and use a feeler gauge of that thickness)

12 Check the valve stem-to-guide clearance by measuring the lateral movement of the valve stem with a dial indicator (see illustration). The valve must be in the guide and approximately 2.0 mm off the seat. The total valve stem movement indicated by the gauge needle must be divided by two, to obtain the actual clearance. After this is done, if there's still some doubt regarding the condition of the valve guides, they should be checked by a machine shop (the cost should be minimal).

#### Valves

13 Carefully inspect each valve face for uneven wear, deformation, cracks, pits and burned areas (see illustration). Check the valve stem for scuffing and the neck for cracks. Rotate the valve, and check for any obvious indication that it's bent. Look for pits and excessive wear on the end of the stem. The presence of any of these conditions indicates the need for valve service as described in the next Section.

14 Measure the margin width on each valve (see illustration). Any valve with a margin narrower than specified will have to be replaced with a new one.

#### Valve components

15 Check each valve spring for wear on the ends. The tension of all springs should be checked with a special fixture before deciding

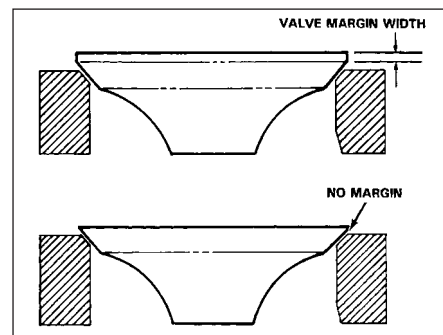

9.14 The margin width on each valve must be as specified (if no margin exists, the valve cannot be reused)

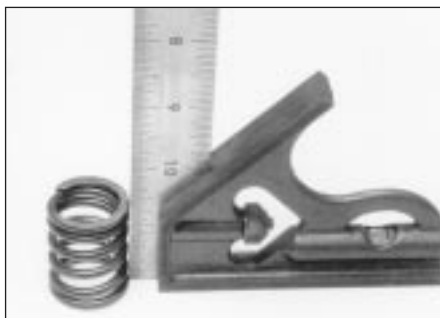

9.16 Check each valve spring for squareness

that they're suitable for use in a rebuilt engine (take the springs to a machine shop for this check).

16 Stand each spring on a flat surface, and check it for squareness (see illustration). If any of the springs are distorted or sagged, or possibly have a broken coil, fit new parts.

17 Check the spring retainers and keepers for obvious wear and cracks. Any questionable parts should be renewed, as extensive damage will occur if they fail during engine operation.

### Rocker arms (M10, M20 and M30 engines)

**Note:** The rocker arms for the exhaust valves are the most subject to wear, and should be checked with particular care.

18 Inspect all the rocker arms for excessive wear on the tips that contact the valve stem and camshaft (see illustration).

19 Check the rocker arm radial clearance (see Section 8). If it's excessive, either the rocker arm bush or the shaft (or both) is excessively worn. To determine which is more worn, slide the rocker arm onto an unworn portion of the rocker arm shaft, and check the radial clearance again. If it's now within specifications, the shaft is probably the most-worn component. If it's not within specifications, the rocker arm bushes should be renewed.

### Rocker arm shafts (M10, M20 and M30 engines)

20 Check the shafts for scoring, excessive wear and other damage. The areas where the



9.18 Look for signs of pitting, discoloration or excessive wear on the ends of the rocker arms where they contact the camshaft and the valve stem tip

rocker arms contact the shafts should be smooth. If there is a visible ridge at the edge of where the rocker arm rides, the shaft is probably worn excessively.

### Cam followers and hydraulic tappets (M40 engines)

21 Check the cam followers where they contact the valve stems and pivot posts for wear, scoring and pitting. If there is excessive wear on both the followers and camshaft, then a new camshaft, complete with cam followers, must be obtained.

22 Similarly check the hydraulic tappets where they contact the bores in the cylinder head for wear, scoring and pitting. Occasionally, a hydraulic tappet may be noisy and require renewal, and this will have been noticed when the engine was running. It is not easy to check a tappet for internal damage or wear once it has been removed; if there is any doubt, a complete set of new tappets should be fitted.

### Camshaft

23 Inspect the camshaft journals (the round bearing areas) and lobes for scoring, pitting, flaking and excessive wear. Using a micrometer, measure the height of each exhaust and intake lobe. Compare the heights of all the exhaust lobes and intake lobes. If the readings among the exhaust valve lobes or intake valve lobes vary more than about 0.08 mm, or if the camshaft is exhibiting any signs of wear, renew the camshaft.

24 Inspect the camshaft bearing surfaces in the cylinder head for scoring and other damage. If the bearing surfaces are scored or damaged, you'll normally have to renew the cylinder head, since the bearings are simply a machined surface in the cylinder head. **Note:** A machine shop (particularly one that specialises in BMWs) or dealer service department may be able to provide an alternative to fitting a new cylinder head, if the only problem with the head is mildly-scored camshaft bearing surfaces.

25 Using a micrometer, measure the journals on the camshaft, and record the measurements (see illustration). Using a telescoping gauge or inside micrometer,



9.25 Measure each camshaft bearing journal and its corresponding bearing diameter in the cylinder head, then subtract the journal diameter from the bearing inside diameter to obtain the oil clearance

measure the camshaft bearing diameters in the cylinder head (on the M40 engine, refit the bearing caps first). Subtract the camshaft journal measurement from its corresponding bearing inside diameter to obtain the oil clearance. Compare the oil clearance to what's listed in this Chapter's Specifications. If it's not within tolerance, a new camshaft and/or cylinder head will be required. **Note:** Before fitting a new cylinder head, check with a machine shop (particularly one that specialises in BMWs). They may be able to repair the head.

## 10 Valves - servicing



1 Examine the valves as described in Section 9, paragraphs 13 and 14. Renew any valve that shows signs of wear or damage.

2 If the valve appears satisfactory at this stage, measure the valve stem diameter at several points using a micrometer (see illustration 9.13). Any significant difference in the readings obtained indicates wear of the valve stem. Should any of these conditions be apparent, the valve(s) must be renewed.

3 If the valves are in satisfactory condition they should be ground (lapped) into their respective seats to ensure a gas-tight seal. If the seat is only lightly pitted, or if it has been re-cut, fine grinding compound should be used to produce the required finish. Coarse valve-grinding compound should not normally be used, unless a seat is badly burned or deeply pitted. If this is the case, the cylinder head and valves should be inspected by an expert, to decide whether seat re-cutting or even the renewal of the valve or seat insert is required.

4 Valve grinding is carried out as follows. Place the cylinder head upside-down on a bench, with a block of wood at each end to give clearance for the valve stems.

5 Smear a trace of the appropriate grade of valve-grinding compound on the seat face, and press a suction grinding tool onto the valve head. With a semi-rotary action, grind the valve head to its seat, lifting the valve occasionally to redistribute the grinding compound (see illustration).



10.5 Grinding-in a valve - do not grind-in the valves any more than absolutely necessary, or their seats will be prematurely sunk into the cylinder head



**11.4a** Lubricate the valve guide seal, and place it on the guide (the valve should be in place too) . . .



**11.4b** . . .then lightly drive on the seal with a socket or piece of tubing



**11.6** With the retainer fitted, compress the valve spring and refit the collets as shown

**HAYNES HINT** *A light spring placed under the valve head will greatly ease the valve grinding operation.*

**6** If coarse grinding compound is being used, work only until a dull, matt even surface is produced on both the valve seat and the valve, then wipe off the used compound and repeat the process with fine compound. When a smooth, unbroken ring of light grey matt finish is produced on both the valve and seat, the grinding operation is complete. **Do not** grind in the valves any further than absolutely necessary.

**7** When all the valves have been ground-in, carefully wash off **all** traces of grinding compound using paraffin or a suitable solvent before reassembly of the cylinder head.

## 11 Cylinder head - reassembly



**1** Make sure the cylinder head is spotlessly-clean before beginning reassembly.

**2** If the head was sent out for valve servicing, the valves and related components will already be in place. Begin the reassembly procedure with paragraph 8.

**3** Starting at one end of the head, apply



**11.9** Lubricate the camshaft bearing journals and lobes with engine assembly paste or molybdenum disulphide ("moly") grease

molybdenum disulphide ("moly") grease or clean engine oil to each valve stem, and refit the first valve.

**4** Lubricate the lip of the valve guide seal, carefully slide it over the tip of the valve, then slide it all the way down the stem to the guide. Using a hammer and a deep socket or seal-fitting tool, gently tap the seal into place until it's completely seated on the guide (**see illustrations**). Don't twist or distort a seal during fitting, or it won't seal properly against the valve stem. **Note:** *On some engines, the seals for intake and exhaust valves are different - don't mix them up.*

**5** Drop the spring seat or shim(s) over the valve guide, and set the valve spring and retainer in place.

**6** Compress the spring with a valve spring compressor and carefully refit the collets in the upper groove, then slowly release the compressor and make sure the collets seat properly (**see illustration**).



**TOOL TIP**  
Apply a small dab of grease to each collet to hold it in place, if necessary.

**7** Repeat paragraphs 3 to 6 for each of the valves. Be sure to return the components to their original locations - don't mix them up!

### M10, M20 and M30 engines

**8** Refit the rocker arms and shafts by reversing the dismantling sequence. Be sure to refit the rocker shafts in the correct orientation. The guide plate notches and the small oil holes face inwards; the large oil holes face down, toward the valve guides.

**9** Lubricate the camshaft journals and lobes

(**see illustration**), then carefully insert it into the cylinder head, rotating it as you go so the camshaft lobes will clear the rocker arms. It will also be necessary to compress the rocker arms against the valve springs, as described in Section 8, so they'll clear the camshaft lobes. Be very careful not to scratch or gouge the camshaft bearing surfaces in the cylinder head.

### M40 engines

**10** Lubricate the bores for the hydraulic tappets in the cylinder head, then insert the tappets in their original positions.

**11** Locate the thrust discs and cam followers on the valves and pivot posts in their original positions.

**12** Lubricate the bearing surfaces of the camshaft in the cylinder head.

**13** Locate the camshaft in the cylinder head so that the valves of No 1 cylinder are both open, and the valves of No 4 cylinder are "rocking" (exhaust closing and inlet opening). No 1 cylinder is at the timing belt end.

**14** Lubricate the bearing surfaces in the bearing caps, then locate them in their correct positions and insert the retaining bolts. Progressively tighten the bolts to the specified torque.

**15** Fit a new oil seal to the camshaft front bearing cap (see Chapter 2A, Section 11).

### All engines

**16** Refit the oil supply tube to the top of the cylinder head together with new seals, then tighten the bolts to the specified torque.

**17** The cylinder head may now be refitted (see Chapter 2A).

## 12 Pistons/connecting rods - removal



**Note:** *Before removing the piston/connecting rod assemblies, remove the cylinder head and the sump. On M10, M20 and M30 engines only, remove the oil pump. Refer to the appropriate Sections in Chapter 2A.*

**1** Use your fingernail to feel if a ridge has formed at the upper limit of ring travel (about 6 mm down from the top of each cylinder). If

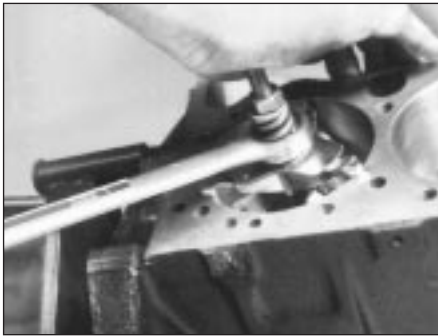

**12.1** A ridge reamer is required to remove the ridge from the top of each cylinder - do this before removing the pistons!

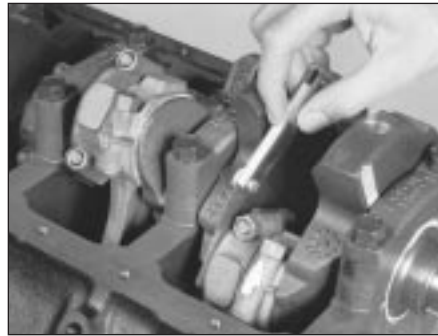

**12.3** Check the connecting rod side play with a feeler gauge as shown



**12.4** Mark the big-end bearing caps in order from the front of the engine to the rear (one mark for the front cap, two for the second one and so on)

carbon deposits or cylinder wear have produced ridges, they must be completely removed with a special tool called a ridge reamer (see illustration). Follow the manufacturer's instructions provided with the tool. Failure to remove the ridges before attempting to remove the piston/connecting rod assemblies may result in piston ring breakage.

**2** After the cylinder ridges have been removed, turn the engine upside-down so the crankshaft is facing up.

**3** Before the connecting rods are removed, check the side play with feeler gauges. Slide them between the first connecting rod and crankshaft web until no play is apparent (see illustration). The side play is equal to the thickness of the feeler gauge(s). If the side play exceeds the service limit, new connecting rods will be required. If new rods (or a new crankshaft) are fitted, ensure that some side play is retained (if not, the rods will have to be machined to restore it - consult a machine shop for advice if necessary). Repeat the procedure for the remaining connecting rods.

**4** Check the connecting rods and caps for identification marks. If they aren't plainly marked, use a small centre-punch to make the appropriate number of indentations (see illustration) on each rod and cap (1, 2, 3, etc., depending on the cylinder they're associated with).

**5** Loosen each of the connecting rod cap nuts/bolts a half-turn at a time until they can be removed by hand. Remove the No 1 connecting rod cap and bearing shell. Don't drop the bearing shell out of the cap.

**6** Where applicable, slip a short length of plastic or rubber hose over each connecting rod cap stud to protect the crankshaft journal and cylinder wall as the piston is removed (see illustration).

**7** Remove the bearing shell, and push the connecting rod/piston assembly out through the top of the engine. Use a wooden hammer handle to push on the upper bearing surface in the connecting rod. If resistance is felt, double-check to make sure that all of the ridge was removed from the cylinder.

**8** Repeat the procedure for the remaining cylinders.

**9** After removal, reassemble the connecting rod caps and bearing shells in their respective connecting rods, and refit the cap nuts/bolts finger-tight. Leaving the old bearing shells in place until reassembly will help prevent the connecting big-end bearing surfaces from being accidentally nicked or gouged.

**10** Don't separate the pistons from the connecting rods (see Section 18).

### 13 Crankshaft - removal



**Note:** *The crankshaft can be removed only after the engine has been removed from the vehicle. It's assumed that the flywheel or driveplate, vibration damper, timing chain or belt, sump, oil pump and piston/connecting rod assemblies have already been removed. The rear main oil seal housing must be unbolted and separated from the block before proceeding with crankshaft removal.*

**1** Before the crankshaft is removed, check the endfloat. Mount a dial indicator with the stem in line with the crankshaft and touching the nose of the crankshaft, or one of its webs (see illustration).

**2** Push the crankshaft all the way to the rear,



**12.6** To prevent damage to the crankshaft journals and cylinder walls, slip sections of rubber or plastic hose over the rod bolts before removing the pistons

and zero the dial indicator. Next, prise the crankshaft to the front as far as possible, and check the reading on the dial indicator. The distance that it moves is the endfloat. If it's greater than the maximum endfloat listed in this Chapter's Specifications, check the crankshaft thrust surfaces for wear. If no wear is evident, new main bearings should correct the endfloat.

**3** If a dial indicator isn't available, feeler gauges can be used. Identify the main bearing with the thrust flanges either side of it - this is referred to as the "thrust" main bearing (see Section 24, paragraph 6). Gently prise or push the crankshaft all the way to the front of the engine. Slip feeler gauges between the crankshaft and the front face of the thrust main bearing to determine the clearance.

**4** Check the main bearing caps to see if they're marked to indicate their locations. They should be numbered consecutively from the front of the engine to the rear. If they aren't, mark them with number-stamping dies or a centre-punch (see illustration). Main bearing caps generally have a cast-in arrow, which points to the front of the engine. Loosen the main bearing cap bolts a quarter-turn at a time each, working from the outer ends towards the centre, until they can be removed by hand. Note if any stud bolts are used, and make sure they're returned to their original locations when the crankshaft is refitted.

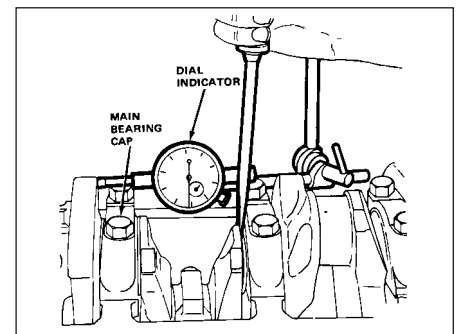

**13.1** Checking crankshaft endfloat with a dial indicator

5 Gently tap the caps with a soft-faced hammer, then separate them from the engine block. If necessary, use the bolts as levers to remove the caps. Try not to drop the bearing shells if they come out with the caps.

6 Carefully lift the crankshaft out of the engine. It may be a good idea to have an assistant available, since the crankshaft is quite heavy (see illustration). With the bearing shells in place in the engine block and main bearing caps, return the caps to their respective locations on the engine block, and tighten the bolts finger-tight.



13.4 Use a centre-punch or number-stamping dies to mark the main bearing caps to ensure refitting in their original locations on the block (make the punch marks near one of the bolt heads)



13.6 Remove the crankshaft by lifting straight up. Be very careful when removing the crankshaft - it is very heavy

## 14 Intermediate shaft - removal and inspection



**Note:** The intermediate shaft is used on the M20 engine only. The shaft rotates in the engine block parallel to the crankshaft. It is driven by the timing belt, and its only purpose is to drive the oil pump.

- 1 Remove the timing belt (see Chapter 2A).
- 2 With the belt removed, unbolt the gear from the intermediate shaft and unbolt the front cover.
- 3 Remove the oil pump driveshaft (see Chapter 2A).
- 4 The shaft is held in the cylinder block by a retaining plate with two bolts. Remove the bolts, and pull the shaft forwards and out of the block.
- 5 Look for any signs of abnormal wear on the bearing surfaces or the gear at the back end of the shaft, which drives the oil pump shaft. If the bearing surfaces in the engine block show wear, they'll have to be attended to by a machine shop.

## 15 Engine block - cleaning



**Caution:** The core plugs may be difficult or impossible to retrieve if they're driven into the block coolant passages.

- 1 Remove the core plugs from the engine block. To do this, knock one side of each plug into the block with a hammer and punch, grasp the other side by its edge with large pliers, and pull it out.
- 2 Using a gasket scraper, remove all traces of gasket material from the engine block. Be very careful not to nick or gouge the gasket sealing surfaces.
- 3 Remove the main bearing caps, and separate the bearing shells from the caps and the engine block. Tag the bearings, indicating which cylinder they were removed from and whether they were in the cap or the block, then set them aside.
- 4 Remove all of the threaded oil gallery plugs from the block. The plugs are usually very tight - they may have to be drilled out and the

holes retapped. Use new plugs when the engine is reassembled.

5 If the engine is extremely dirty, it should be taken to a machine shop to be steam-cleaned.

6 After the block is returned, clean all oil holes and oil galleries one more time. Brushes specifically designed for this purpose are available at most motor factors. Flush the passages with warm water until the water runs clear, dry the block thoroughly, and wipe all machined surfaces with a light, rust-preventive oil. If you have access to compressed air, use it to speed the drying process and to blow out all the oil holes and galleries.



**Warning:** Wear eye protection when using compressed air!

7 If the block isn't extremely dirty or sludged up, you can do an adequate cleaning job with hot soapy water and a stiff brush. Take plenty of time, and do a thorough job. Regardless of the cleaning method used, be sure to clean all oil holes and galleries very thoroughly, dry the block completely, and coat all machined surfaces with light oil.

8 The threaded holes in the block must be clean to ensure accurate torque readings



15.8 All bolt holes in the block - particularly the main bearing cap and head bolt holes - should be cleaned and restored with a tap (be sure to remove debris from the holes after this is done)

during reassembly. Run the proper-size tap into each of the holes to remove rust, corrosion, thread sealant or sludge, and to restore damaged threads (see illustration). If possible, use compressed air to clear the holes of debris produced by this operation. Be sure also that the holes are **dry** - any oil or other fluid present could cause the block to be cracked by hydraulic pressure when the bolts are tightened. Now is a good time to clean the threads on all bolts. Note that BMW recommend that the cylinder head bolts and main bearing bolts are renewed as a matter of course.

9 Refit the main bearing caps, and tighten the bolts finger-tight.

10 After coating the sealing surfaces of the new core plugs with a suitable sealant, refit them in the engine block (see illustration). Make sure they're driven in straight and seated properly, or leakage could result. Special tools are available for this purpose, but a large socket, with an outside diameter that will just slip into the core plug, a 1/2-inch drive extension, and a hammer, will work just as well.

11 Apply non-hardening sealant to the new oil gallery plugs, and thread them into the holes in the block. Make sure they're tightened securely.

12 If the engine isn't going to be reassembled right away, cover it with a large plastic bag to keep it clean.



15.10 A large socket on an extension can be used to drive the new core plugs into the block

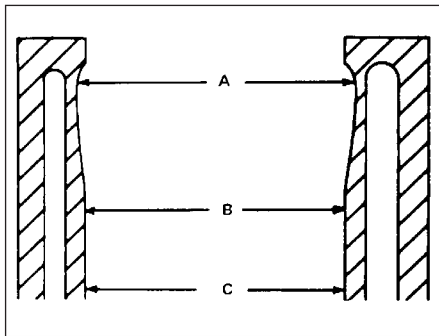

16.4a Measure the diameter of each cylinder just under the wear ridge (A), at the centre (B) and at the bottom (C)

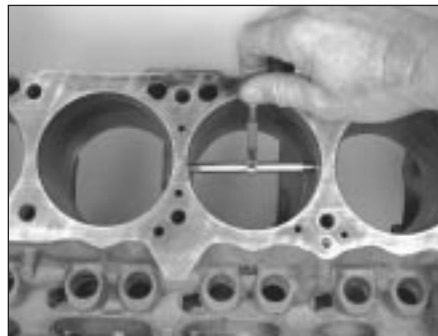

16.4b The ability to “feel” when the telescoping gauge is at the correct point will be developed over time, so work slowly, and repeat the check until you’re satisfied the bore measurement is accurate



16.4c The gauge is then measured with a micrometer to determine the bore size

## 16 Engine block - inspection



1 Before the block is inspected, it should be cleaned (see Section 15).

2 Visually check the block for cracks, rust and corrosion. Look for stripped threads in the threaded holes. It’s also a good idea to have the block checked for hidden cracks by a machine shop that has the special equipment to do this type of work. If defects are found, have the block repaired, if possible; otherwise, a new block will be required.

3 Check the cylinder bores for scuffing and scoring.

4 Measure the diameter of each cylinder at the top (just under the wear ridge area), centre and bottom of the cylinder bore, parallel to the crankshaft axis (see illustrations).

5 Next, measure each cylinder’s diameter at the same three locations across the crankshaft axis. Compare the results to this Chapter’s Specifications.

6 If the required precision measuring tools aren’t available, the piston-to-cylinder clearances can be obtained, though not quite as accurately, using feeler gauges.

7 To check the clearance, select a feeler gauge, and slip it into the cylinder along with the matching piston. The piston must be positioned exactly as it normally would be. The feeler gauge must be between the piston and cylinder on one of the thrust faces (90° to the gudgeon pin bore).

8 The piston should slip through the cylinder (with the feeler gauge in place) with moderate pressure.

9 If it falls through or slides through easily, the clearance is excessive, and a new piston will be required. If the piston binds at the lower end of the cylinder and is loose toward the top, the cylinder is tapered. If tight spots are encountered as the piston/feeler gauge is rotated in the cylinder, the cylinder is out-of-round.

10 Repeat the procedure for the remaining pistons and cylinders.

11 If the cylinder walls are badly scuffed or

scored, or if they’re out-of-round or tapered beyond the limits given in this Chapter’s Specifications, have the engine block rebored and honed at a machine shop. If a rebore is done, oversize pistons and rings will be required.

12 If the cylinders are in reasonably good condition and not worn to the outside of the limits, and if the piston-to-cylinder clearances can be maintained properly, then they don’t have to be rebored. Honing (see Section 17) and a new set of piston rings is all that’s necessary.

## 17 Cylinder honing



1 Prior to engine reassembly, the cylinder bores must be honed so the new piston rings will seat correctly and provide the best possible combustion chamber seal. **Note:** If you don’t have the tools, or don’t want to tackle the honing operation, most machine shops will do it for a reasonable fee.

2 Before honing the cylinders, refit the main bearing caps, and tighten the bolts to the torque listed in this Chapter’s Specifications.

3 Two types of cylinder hones are commonly available - the flex hone or “bottle brush”



17.4 A “bottle brush” hone will produce better results if you’ve never honed cylinders before

type, and the more traditional surfacing hone with spring-loaded stones. Both will do the job, but for the less-experienced mechanic, the “bottle brush” hone will probably be easier to use. You’ll also need some paraffin or honing oil, rags and an electric drill. Proceed as follows.

4 Mount the hone in the drill, compress the stones, and slip it into the first cylinder (see illustration). Be sure to wear safety goggles or a face shield!

5 Lubricate the cylinder with plenty of honing oil, turn on the drill, and move the hone up and down in the cylinder at a pace that will produce a fine crosshatch pattern on the cylinder walls. Ideally, the crosshatch lines should intersect at approximately a 60° angle (see illustration). Be sure to use plenty of lubricant, and don’t take off any more material than is absolutely necessary to produce the desired finish. **Note:** Piston ring manufacturers may specify a smaller crosshatch angle than the traditional 60° - read and follow any instructions included with the new rings.

6 Don’t withdraw the hone from the cylinder while it’s running. Instead, shut off the drill and continue moving the hone up and down in the cylinder until it comes to a complete stop, then compress the stones and withdraw the hone. If you’re using a “bottle brush” type hone, stop the drill, then turn the chuck in the normal direction of rotation while withdrawing the hone from the cylinder.

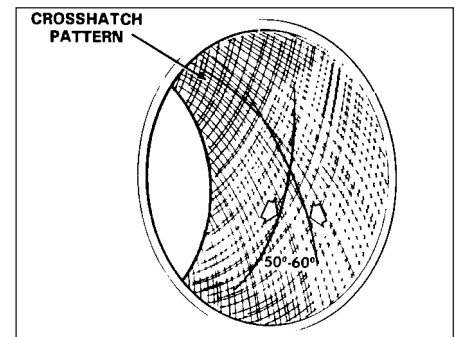

17.5 The cylinder hone should leave a smooth, crosshatch pattern, with the lines intersecting at approximately a 60° angle



**18.2** Removing the compression rings with a ring expander - note the mark (arrowed) facing up

7 Wipe the oil out of the cylinder, and repeat the procedure for the remaining cylinders.

8 After the honing job is complete, chamfer the top edges of the cylinder bores with a small file, so the rings won't catch when the pistons are refitted. Be very careful not to nick the cylinder walls with the end of the file.

9 The entire engine block must be washed again very thoroughly with warm, soapy water, to remove all traces of the abrasive grit produced during the honing operation. **Note:** *The bores can be considered clean when a lint-free white cloth - dampened with clean engine oil - used to wipe them out doesn't pick up any more honing residue, which will show up as grey areas on the cloth.* Be sure to run a brush through all oil holes and galleries, and flush them with running water.

10 After rinsing, dry the block, and apply a coat of light rust-preventive oil to all machined surfaces. Wrap the block in a plastic bag to keep it clean, and set it aside until reassembly.

## 18 Pistons/connecting rods - inspection



1 Before the inspection process can be carried out, the piston/connecting rod assemblies must be cleaned and the original piston rings removed from the pistons. **Note:** *Always use new piston rings when the engine is reassembled.*

2 Using a piston ring refitting tool, carefully remove the rings from the pistons. Be careful not to nick or gouge the pistons in the process (see illustration).

3 Scrape all traces of carbon from the top of the piston. A hand-held wire brush or a piece of fine emery cloth can be used once the majority of the deposits have been scraped away. Do not, under any circumstances, use a wire brush mounted in a drill motor to remove deposits from the pistons. The piston material is soft, and may be damaged by the wire brush.

4 Use a piston ring groove cleaning tool to remove carbon deposits from the ring grooves. Be very careful to remove only the



**18.4** The piston ring grooves can be cleaned with a special tool, as shown here

carbon deposits - don't remove any metal, and do not nick or scratch the sides of the ring grooves (see illustration).



**If a groove cleaning tool isn't available, a piece broken off the old ring will do the job, but protect your hands - piston rings can be sharp**

5 Once the deposits have been removed, clean the piston/rod assemblies with solvent, and dry them with compressed air (if available). Make sure the oil return holes in the back sides of the ring grooves are clear.

6 If the pistons and cylinder walls aren't damaged or worn excessively, and if the engine block is not rebored, new pistons won't be necessary. Normal piston wear appears as even vertical wear on the piston thrust surfaces (90° to the gudgeon pin bore), and slight looseness of the top ring in its groove. New piston rings, however, should always be used when an engine is rebuilt.

7 Carefully inspect each piston for cracks around the skirt, at the pin bosses, and at the ring lands.

8 Look for scoring and scuffing on the thrust faces of the skirt, holes in the piston crown, and burned areas at the edge of the crown. If the skirt is scored or scuffed, the engine may have been suffering from overheating and/or abnormal combustion, which caused excessively high operating temperatures. The cooling and lubrication systems should be checked thoroughly. A hole in the piston crown is an indication that abnormal combustion (pre-ignition) was occurring. Burned areas at the edge of the piston crown are usually evidence of spark knock (detonation). If any of the above



**18.10** Check the ring side clearance with a feeler gauge at several points around the groove

problems exist, the causes must be corrected, or the damage will occur again. The causes may include intake air leaks, incorrect fuel/air mixture, or incorrect ignition timing. On later vehicles with high levels of exhaust emission control, including catalytic converters, the problem may be with the EGR (exhaust gas recirculation) system, where applicable.

9 Corrosion of the piston, in the form of small pits, indicates that coolant is leaking into the combustion chamber and/or the crankcase. Again, the cause must be corrected or the problem may persist in the rebuilt engine.

10 Measure the piston ring side clearance by laying a new piston ring in each ring groove and slipping a feeler gauge in beside it (see illustration). Check the clearance at three or four locations around each groove. Be sure to use the correct ring for each groove - they are different. If the side clearance is greater than the figure listed in this Chapter's Specifications, new pistons will have to be used.

11 Check the piston-to-bore clearance by measuring the bore (see Section 16) and the piston diameter. Make sure the pistons and bores are correctly matched. Measure the piston across the skirt, at 90° to, and in line with, the gudgeon pin (see illustration). (Any difference between these two measurements indicates that the piston is no longer perfectly round.) Subtract the piston diameter from the bore diameter to obtain the clearance. If it's greater than specified, the block will have to be rebored, and new pistons and rings fitted.



**18.11** Measure the piston diameter at a 90-degree angle to the gudgeon pin, at the same height as the gudgeon pin





19.1 The oil holes should be chamfered so sharp edges don't gouge or scratch the new bearings



19.2 Use a wire or stiff plastic bristle brush to clean the oil passages in the crankshaft



19.4 Rubbing a penny lengthways on each journal will reveal its condition - if copper rubs off and is embedded in the crankshaft, the journals should be reground

12 Check the piston-to-rod clearance by twisting the piston and rod in opposite directions. Any noticeable play indicates excessive wear, which must be corrected. The piston/connecting rod assemblies should be taken to a machine shop for attention.

13 If the pistons must be removed from the connecting rods for any reason, they should be taken to a machine shop. When this is done, have the connecting rods checked for bend and twist, since most machine shops have special equipment for this purpose.

**Note:** Unless new pistons and/or connecting rods must be fitted, do not dismantle the pistons and connecting rods.

14 Check the connecting rods for cracks and other damage. Temporarily remove the rod caps, lift out the old bearing shells, wipe the rod and cap bearing surfaces clean, and inspect them for nicks, gouges and scratches. After checking the rods, fit new bearing shells, slip the caps into place, and tighten the nuts finger-tight.

## 19 Crankshaft - inspection



1 Remove all burrs from the crankshaft oil holes with a stone, file or scraper (see illustration).

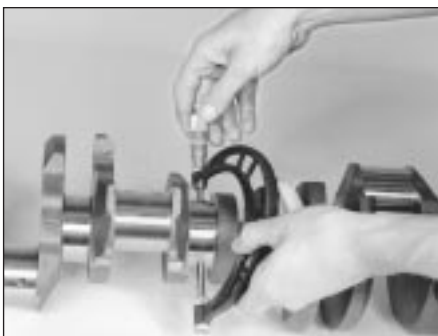

19.6 Measure the diameter of each crankshaft journal at several points to detect taper and out-of-round conditions



19.8 If the seals have worn grooves in the crankshaft journals, or if the seal contact surfaces are nicked or scratched, the new seals will leak

2 Clean the crankshaft with solvent, and dry it with compressed air (if available). Be sure to clean the oil holes with a stiff brush (see illustration), and flush them with solvent.

3 Check the main and connecting big-end bearing journals for uneven wear, scoring, pits and cracks.

4 Rub a copper coin across each journal several times (see illustration). If a journal picks up copper from the coin, it's too rough and must be reground.

5 Check the rest of the crankshaft for cracks and other damage. If necessary, have a machine shop inspect the crankshaft.

6 Using a micrometer, measure the diameter of the main and connecting rod journals, and compare the results to this Chapter's Specifications (see illustration). By measuring the diameter at a number of points around each journal's circumference, you'll be able to determine whether or not the journal is out-of-round. Take the measurement at each end of the journal, near the crank webs, to determine if the journal is tapered.

7 If the crankshaft journals are damaged, tapered, out-of-round or worn beyond the limits given in the Specifications, have the crankshaft reground by a machine shop. Be sure to use the correct-size bearing shells if the crankshaft is reconditioned.

8 Check the oil seal journals at each end of

the crankshaft for wear and damage. If the seal has worn a groove in the journal, or if it's nicked or scratched (see illustration), the new seal may leak when the engine is reassembled. In some cases, a machine shop may be able to repair the journal by pressing on a thin sleeve. If repair isn't feasible, a new or different crankshaft should be fitted.

9 Examine the main and big-end bearing shells (see Section 20).

## 20 Main and connecting big-end bearings - inspection



1 Even though the main and connecting big-end bearings should be renewed during the engine overhaul, the old bearings should be retained for close examination, as they may reveal valuable information about the condition of the engine (see illustration).

2 Bearing failure occurs because of lack of lubrication, the presence of dirt or other foreign particles, overloading the engine, and corrosion. Regardless of the cause of bearing failure, it must be corrected before the engine is reassembled, to prevent it from happening again.

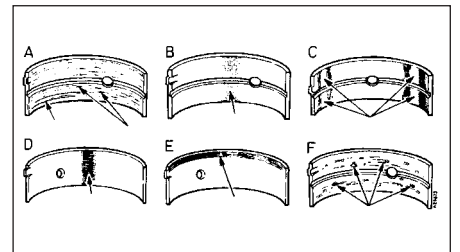

20.1 Typical bearing failures

- A Scratched by dirt: debris embedded into bearing material
- B Lack of oil: overlay wiped out
- C Improper seating: bright (polished) sections
- D Tapered journal: overlay gone from entire surface
- E Radius ride
- F Fatigue failure: craters or pockets

3 When examining the bearings, remove them from the engine block, the main bearing caps, the connecting rods and the rod caps, and lay them out on a clean surface in the same general position as their location in the engine. This will enable you to match any bearing problems with the corresponding crankshaft journal.

4 Dirt and other foreign particles get into the engine in a variety of ways. It may be left in the engine during assembly, or it may pass through filters or the crankcase ventilation (PCV) system. It may get into the oil, and from there into the bearings. Metal chips from machining operations and normal engine wear are often present. Abrasives are sometimes left in engine components after reconditioning, especially when parts are not thoroughly cleaned using the proper cleaning methods. Whatever the source, these foreign objects often end up embedded in the soft bearing material, and are easily recognised. Large particles will not embed in the bearing, and will score or gouge the bearing and journal. The best prevention for this cause of bearing failure is to clean all parts thoroughly, and to keep everything spotlessly-clean during engine assembly. Frequent and regular engine oil and filter changes are also recommended.

5 Lack of lubrication (or lubrication breakdown) has a number of interrelated causes. Excessive heat (which thins the oil), overloading (which squeezes the oil from the bearing face) and oil "leakage" or "throw off" (from excessive bearing clearances, worn oil pump, or high engine speeds) all contribute to lubrication breakdown. Blocked oil passages, which usually are the result of misaligned oil holes in a bearing shell, will also oil-starve a bearing and destroy it. When lack of lubrication is the cause of bearing failure, the bearing material is wiped or extruded from the steel backing of the bearing. Temperatures may increase to the point where the steel backing turns blue from overheating.

6 Driving habits can have a definite effect on bearing life. Full-throttle, low-speed operation (labouring the engine) puts very high loads on

bearings, which tends to squeeze out the oil film. These loads cause the bearings to flex, which produces fine cracks in the bearing face (fatigue failure). Eventually, the bearing material will loosen in places, and tear away from the steel backing. Short-trip driving leads to corrosion of bearings, because insufficient engine heat is produced to drive off the condensation and corrosive gases. These products collect in the engine oil, forming acid and sludge. As the oil is carried to the engine bearings, the acid attacks and corrodes the bearing material.

7 Incorrect bearing refitting during engine assembly will lead to bearing failure as well. Tight-fitting bearings leave insufficient bearing oil clearance, and will result in oil starvation. Dirt or foreign particles trapped behind a bearing shell result in high spots on the bearing, which will lead to failure.

### 21 Engine overhaul - reassembly sequence

1 Before beginning engine reassembly, make sure you have all the necessary new parts, gaskets and seals, as well as the following items on hand:

- Common hand tools*
- A torque wrench*
- Piston ring refitting tool*
- Piston ring compressor*
- Vibration damper refitting tool*
- Short lengths of rubber or plastic hose to fit over connecting rod bolts (where applicable)*
- Plastigage*
- Feeler gauges*
- A fine-tooth file*
- New engine oil*
- Engine assembly oil or molybdenum disulphide ("moly") grease*
- Gasket sealant*
- Thread-locking compound*

2 In order to save time and avoid problems, engine reassembly should be done in the following general order:

- Piston rings*
- Crankshaft and main bearings*
- Piston/connecting rod assemblies*
- Oil pump*
- Sump*
- Cylinder head assembly*
- Timing belt or chain and tensioner assemblies*
- Water pump*
- Timing belt or chain covers*
- Intake and exhaust manifolds*
- Valve cover*
- Engine rear plate*
- Flywheel/driveplate*

### 22 Piston rings - refitting

1 Before fitting the new piston rings, the ring end gaps must be checked. It's assumed that the piston ring side clearance has been checked and verified (see Section 18).

2 Lay out the piston/connecting rod assemblies and the new ring sets, so that the ring sets will be matched with the same piston and cylinder during the end gap measurement and engine assembly.

3 Insert the top ring into the first cylinder, and square it up with the cylinder walls by pushing it in with the top of the piston (see illustration). The ring should be near the bottom of the cylinder, at the lower limit of ring travel.

4 To measure the end gap, slip feeler gauges between the ends of the ring until a gauge equal to the gap width is found (see illustration). The feeler gauge should slide between the ring ends with a slight amount of drag. Compare the measurement to this Chapter's Specifications. If the gap is larger or smaller than specified, double-check to make sure you have the correct rings before proceeding.

5 If the gap is too small, it must be enlarged, or the ring ends may come in contact with each other during engine operation, which can cause serious damage to the engine. The end gap can be increased by filing the ring ends very carefully with a fine file. Mount the



22.3 When checking piston ring end gap, the ring must be square in the cylinder bore (this is done by pushing the ring down with the top of a piston as shown)



22.4 With the ring square in the cylinder, measure the end gap with a feeler gauge



22.5 If the end gap is too small, clamp a file in a vice, and file the ring ends (from the outside in only) to enlarge the gap slightly





**22.9a Refitting the spacer/expander in the oil control ring groove**

file in a vice equipped with soft jaws, slip the ring over the file, with the ends contacting the file face, and slowly move the ring to remove material from the ends. When performing this operation, file only from the outside in (see illustration).

**6** Excess end gap isn't critical unless it's greater than 1.0 mm. Again, double-check to make sure you have the correct rings for your engine.

**7** Repeat the procedure for each ring that will be fitted in the first cylinder and for each ring in the remaining cylinders. Remember to keep rings, pistons and cylinders matched up.

**8** Once the ring end gaps have been checked/corrected, the rings can be fitted on the pistons.

**9** The oil control ring (lowest one on the piston) is usually fitted first. It's normally composed of three separate components. Slip the spacer/expander into the groove (see illustration). If an anti-rotation tang is used, make sure it's inserted into the drilled hole in the ring groove. Next, refit the lower side rail. Don't use a piston ring refitting tool on the oil ring side rails, as they may be damaged. Instead, place one end of the side rail into the groove between the spacer/expander and the ring land, hold it firmly in place, and slide a finger around the piston while pushing the rail into the groove (see illustration). Next, refit the upper side rail in the same manner.

**10** After the three oil ring components have been fitted, check to make sure that both the upper and lower side rails can be turned smoothly in the ring groove.

**11** The middle ring is fitted next. It's usually stamped with a mark which must face up, towards the top of the piston. **Note:** Always follow the instructions printed on the ring package or box - different manufacturers may require different approaches. Do not mix up the top and middle rings, as they have different cross-sections.

**12** Make sure the identification mark is facing the top of the piston, then slip the ring into the middle groove on the piston (see illustration 18.2). Don't expand the ring any more than necessary to slide it over the piston. Use a proper ring-fitting tool if available; with care, old feeler gauges can be used to prevent the rings dropping into empty grooves.



**22.9b DO NOT use a piston ring refitting tool when refitting the oil ring side rails**

**13** Refit the top ring in the same manner. Make sure the mark is facing upwards. Be careful not to confuse the top and middle rings.

**14** Repeat the procedure for the remaining pistons and rings.

## 23 Intermediate shaft - refitting

**1** Clean the intermediate shaft bearing surfaces and the pressed-in bearing sleeves in the cylinder block.

**2** Lubricate the shaft, and slide it into the block.

**3** Refit the two bolts that hold the retaining plate to the block.

**4** The remainder of the parts are fitted in the reverse order of removal.

## 24 Crankshaft - refitting and main bearing oil clearance check

**1** Crankshaft refitting is the first major step in engine reassembly. It's assumed at this point that the engine block and crankshaft have been cleaned, inspected, and repaired or reconditioned.

**2** Position the block upside-down.

**3** Remove the main bearing cap bolts, and lift



**24.6 Refitting a thrust main bearing (note the flanges) in the engine block bearing saddle**

out the caps. Lay them out in the proper order to ensure correct refitting.

**4** If they're still in place, remove the original bearing shells from the block and the main bearing caps. Wipe the bearing surfaces of the block and caps with a clean, lint-free cloth. They must be kept spotlessly-clean.

### Main bearing oil clearance check

**5** Clean the back sides of the new main bearing shells, and lay one in each main bearing saddle in the block. If one of the bearing shells from each set has a large groove in it, make sure the grooved shell is fitted in the block. Lay the other bearing from each set in the corresponding main bearing cap. Make sure the tab on the bearing shell fits into the recess in the block or cap.



**Caution:** The oil holes in the block must line up with the oil holes in the bearing shell. Do not hammer the bearing into place, and don't nick or gouge the bearing faces. No lubrication should be used at this time.

**6** The flanged thrust bearing must be fitted in the No 3 bearing cap and saddle in the M10 engine, in the No 6 bearing cap and saddle in the M20 engine (see illustration), in the No 4 bearing cap and saddle in the M30 engine, and in the No 4 bearing saddle only in the M40 engine.

**7** Clean the faces of the bearings in the block and the crankshaft main bearing journals with a clean, lint-free cloth.

**8** Check or clean the oil holes in the crankshaft, as any dirt here can go only one way - straight through the new bearings.

**9** Once you're certain the crankshaft is clean, carefully lay it in position in the main bearings. **10** Before the crankshaft can be permanently fitted, the main bearing oil clearance must be checked.

**11** Cut several pieces of the appropriate-size Plastigage (they must be slightly shorter than the width of the main bearings), and place one piece on each crankshaft main bearing journal, parallel with the crankshaft centreline (see illustration).

**12** Clean the faces of the bearings in the caps, and refit the caps in their respective



**24.11 Lay the Plastigage strips on the main bearing journals, parallel to the crankshaft centreline**



**24.15** Compare the width of the crushed Plastigage to the scale on the envelope to determine the main bearing oil clearance (always take the measurement at the widest point of the Plastigage); be sure to use the correct scale - standard and metric ones are included

positions (don't mix them up) with the arrows pointing towards the front of the engine. Don't disturb the Plastigage.

**13** Starting with the centre main bearing and working out toward the ends, progressively tighten the main bearing cap bolts to the torque listed in this Chapter's Specifications. On M10, M20 and M30 engines, tighten the bolts in three stages. On the M40 engine, tighten all the bolts initially to the Stage 1 torque, then angle-tighten them by the angle given in the Specifications. Carry out the angle-tightening on each bolt in one controlled movement. Don't rotate the crankshaft at any time during the tightening operation.

**14** Remove the bolts and carefully lift off the main bearing caps. Keep them in order. Don't disturb the Plastigage or rotate the crankshaft. If any of the main bearing caps are difficult to remove, tap them gently from side-to-side with a soft-face hammer to loosen them.

**15** Compare the width of the crushed Plastigage on each journal to the scale printed on the Plastigage envelope to obtain the main bearing oil clearance (see illustration). Check the Specifications to make sure it's correct.

**16** If the clearance is not as specified, the

bearing shells may be the wrong size (which means different ones will be required). Before deciding that different shells are needed, make sure that no dirt or oil was between the bearing shells and the caps or block when the clearance was measured. If the Plastigage was wider at one end than the other, the journal may be tapered (see Section 19).

**17** Carefully scrape all traces of the Plastigage material off the main bearing journals and/or the bearing faces. Use your fingernail or the edge of a credit card - don't nick or scratch the bearing faces.

### Final crankshaft refitting

**18** Carefully lift the crankshaft out of the engine.

**19** Clean the bearing faces in the block, then apply a thin, uniform layer of molybdenum disulphide ("moly") grease or engine oil to each of the bearing surfaces. Be sure to coat the thrust faces as well as the journal face of the thrust bearing.

**20** Make sure the crankshaft journals are clean, then lay the crankshaft back in place in the block.

**21** Clean the faces of the bearings in the caps, then apply engine oil to them.

**22** Refit the caps in their respective positions, with the arrows pointing towards the front of the engine.

**23** Refit the bolts finger-tight.

**24** Lightly tap the ends of the crankshaft forward and backward with a lead or brass hammer, to line up the main bearing and crankshaft thrust surfaces.

**25** Tighten the bearing cap bolts to the specified torque, working from the centre outwards. On M10, M20 and M30 engines, tighten the bolts in three stages to the final torque, leaving out the thrust bearing cap bolts at this stage. On M40 engines, tighten all of the bolts in the two stages given in the Specifications.

**26** On M10, M20 and M30 engines, tighten the thrust bearing cap bolts to the torque listed in this Chapter's Specifications.

**27** On manual transmission models, fit a new pilot bearing in the end of the crankshaft (see Chapter 8).

**28** Rotate the crankshaft a number of times by hand to check for any obvious binding.

**29** The final step is to check the crankshaft endfloat with a feeler gauge or a dial indicator as described in Section 13. The endfloat should be correct, providing the crankshaft thrust faces aren't worn or damaged, and new bearings have been fitted.

**30** Fit the new seal, then bolt the housing to the block (see Section 25).

### 25 Crankshaft rear oil seal - refitting



**1** The crankshaft must be fitted first, and the main bearing caps bolted in place. The new seal should then be fitted in the retainer, and the retainer bolted to the block.

**2** Before refitting the crankshaft, check the seal contact surface very carefully for scratches and nicks that could damage the new seal lip and cause oil leaks. If the crankshaft is damaged, the only alternative is a new or different crankshaft, unless a machine shop can suggest a means of repair.

**3** The old seal can be removed from the housing with a hammer and punch by driving it out from the back side (see illustration). Be sure to note how far it's recessed into the housing bore before removing it; the new seal will have to be recessed an equal amount. Be very careful not to scratch or otherwise damage the bore in the housing, or oil leaks could develop.

**4** Make sure the retainer is clean, then apply a thin coat of engine oil to the outer edge of the new seal. The seal must be pressed squarely into the housing bore, so hammering it into place is not recommended. At the very least, use a block of wood as shown, or a section of large-diameter pipe (see illustration). If you don't have access to a press, sandwich the housing and seal between two smooth pieces of wood, and press the seal into place with the jaws of a large vice. The pieces of wood must be thick enough to distribute the force evenly around the entire circumference of the seal. Work



**25.3** After removing the retainer from the block, support it on two wooden blocks, and drive out the old seal with a punch and hammer



**25.4** Drive the new seal into the retainer with a wooden block or a section of pipe, if you have one large enough - make sure the seal enters the retainer bore squarely



**25.5** Lubricate the lip of the seal, and bolt the retainer to the rear of the engine block

slowly, and make sure the seal enters the bore squarely.

5 The seal lips must be lubricated with multi-purpose grease or clean engine oil before the seal/retainer is slipped over the crankshaft and bolted to the block (see illustration). Use a new gasket - no sealant is required - and make sure the dowel pins are in place before refitting the retainer.

6 Tighten the retainer nuts/screws a little at a time until they're all snug, then tighten them to the torque listed in the Specifications in Chapter 2A.

## 26 Pistons/connecting rods - refitting and big-end bearing oil clearance check



1 Before refitting the piston/connecting rod assemblies, the cylinder walls must be perfectly clean, the top edge of each cylinder must be chamfered, and the crankshaft must be in place.

2 Remove the cap from the end of No 1 connecting rod (refer to the marks made during removal). Remove the original bearing shells, and wipe the bearing surfaces of the connecting rod and cap with a clean, lint-free cloth. They must be kept spotlessly-clean.

### Connecting rod big-end bearing oil clearance check

3 Clean the back side of the new upper bearing shell, then lay it in place in the connecting rod. Make sure the tab on the bearing fits into the recess in the rod. Don't hammer the bearing shell into place, and be very careful not to nick or gouge the bearing face. Don't lubricate the bearing at this time.

4 Clean the back side of the other bearing shell, and refit it in the rod cap. Again, make sure the tab on the bearing fits into the recess in the cap, and don't apply any lubricant. It's critically important that the mating surfaces of the bearing and connecting rod are perfectly

clean and oil-free when they're assembled for this check.

5 Position the piston ring gaps so they're staggered 120° from each other.

6 Where applicable, slip a section of plastic or rubber hose over each connecting rod cap bolt.

7 Lubricate the piston and rings with clean engine oil, and attach a piston ring compressor to the piston. Leave the skirt protruding about 6 or 7 mm to guide the piston into the cylinder. The rings must be compressed until they're flush with the piston.

8 Rotate the crankshaft until the No 1 connecting rod journal is at BDC (bottom dead centre). Apply a coat of engine oil to the cylinder walls.

9 With the mark or notch on top of the piston facing the front of the engine, gently insert the piston/connecting rod assembly into the No 1 cylinder bore, and rest the bottom edge of the ring compressor on the engine block.

10 Tap the top edge of the ring compressor to make sure it's contacting the block around its entire circumference.

11 Gently tap on the top of the piston with the end of a wooden hammer handle (see illustration) while guiding the end of the connecting rod into place on the crankshaft journal. Work slowly, and if any resistance is felt as the piston enters the cylinder, stop immediately. Find out what's catching, and fix it before proceeding. Do not, for any reason, force the piston into the cylinder - you might break a ring and/or the piston.

**HAYNES**  
**HINT**

*The piston rings may try to pop out of the ring compressor just before entering the cylinder bore, so keep some downward pressure on the ring compressor*

12 Once the piston/connecting rod assembly is fitted, the connecting rod big-end bearing oil clearance must be checked before the rod cap is permanently bolted in place.

13 Cut a piece of the appropriate-size Plastigage slightly shorter than the width of the connecting rod big-end bearing, and lay it in place on the No 1 connecting rod journal, parallel with the crankshaft centre-line.

14 Clean the connecting rod cap bearing face, remove the protective hoses from the connecting rod bolts, and refit the rod cap. Make sure the mating mark on the cap is on the same side as the mark on the connecting rod.

15 Refit the nuts/bolts, and tighten them to the torque listed in this Chapter's Specifications. On M10 and M30 engines, work up to the final torque in three stages. **Note:** Use a thin-wall socket, to avoid erroneous torque readings that can result if the socket is wedged between the rod cap and nut. If the socket tends to wedge itself between the nut and the cap, lift up on it slightly until it no longer contacts the cap. Do not rotate the crankshaft at any time during this operation.

16 Undo the nuts and remove the rod cap, being very careful not to disturb the Plastigage.

17 Compare the width of the crushed Plastigage to the scale printed on the Plastigage envelope to obtain the oil clearance (see illustration). Compare it to the Specifications to make sure the clearance is correct.

18 If the clearance is not as specified, the bearing shells may be the wrong size (which means different ones will be required). Before deciding that different shells are needed, make sure that no dirt or oil was between the bearing shells and the connecting rod or cap when the clearance was measured. Also, recheck the journal diameter. If the Plastigage was wider at one end than the other, the journal may be tapered (see Section 19).

### Final connecting rod refitting

19 Carefully scrape all traces of the Plastigage material off the rod journal and/or bearing face. Be very careful not to scratch



26.11 Drive the piston gently into the cylinder bore with the end of a wooden or plastic hammer handle



26.17 Measuring the width of the crushed Plastigage to determine the big-end bearing oil clearance (be sure to use the correct scale - standard and metric ones are included)

the bearing - use your fingernail or the edge of a credit card.

**20** Make sure the bearing faces are perfectly clean, then apply a uniform layer of molybdenum disulphide ("moly") grease or engine assembly oil to both of them. You'll have to push the piston into the cylinder to expose the face of the bearing shell in the connecting rod - be sure to slip the protective hoses over the rod bolts first, where applicable.

**21** Slide the connecting rod back into place on the journal, and remove the protective hoses from the rod cap bolts. Refit the rod cap, and tighten the nuts/bolts to the specified torque.

**22** Repeat the entire procedure for the remaining pistons/connecting rods.

**23** The important points to remember are:

- a) *Keep the back sides of the bearing shells and the insides of the connecting rods and caps perfectly clean when assembling them.*
- b) *Make sure you have the correct piston/rod assembly for each cylinder.*
- c) *The notch or mark on the piston must face the front of the engine.*
- d) *Lubricate the cylinder walls with clean oil.*
- e) *Lubricate the bearing faces when refitting the rod caps after the oil clearance has been checked.*

**24** After all the piston/connecting rod assemblies have been properly fitted, rotate the crankshaft a number of times by hand to check for any obvious binding.

**25** Check the connecting rod side play (see Section 13).

**26** Compare the measured side play to the Specifications to make sure it's correct. If it was correct before dismantling, and the original crankshaft and rods were refitted, it should still be right. If new rods or a new crankshaft were fitted, the side play may be incorrect. If so, the rods will have to be removed and taken to a machine shop for attention.

### 27 Initial start-up and running-in after overhaul



**Warning:** Have a fire extinguisher handy when starting the engine for the first time.

**1** Once the engine has been refitted in the vehicle, double-check the engine oil and coolant levels.

**2** With the spark plugs removed and the ignition system disabled (see Section 3), crank the engine until oil pressure registers on the gauge, or until the oil pressure warning light goes out.

**3** Refit the spark plugs, connect the HT leads, and restore the ignition system functions (see Section 3).

**4** Start the engine. It may take a few moments for the fuel system to build up

pressure, but the engine should start without a great deal of effort. **Note:** *If backfiring occurs through the throttle body or carburettor, check the valve timing (check that the timing chain/belt has been correctly fitted), the firing order (check the fitted order of the spark plug HT leads), and the ignition timing.*

**5** After the engine starts, it should be allowed to warm up to normal operating temperature. While the engine is warming up, make a thorough check for fuel, oil and coolant leaks.

**6** Shut the engine off and recheck the engine oil and coolant levels.

**7** Drive the vehicle to an area with minimum traffic, accelerate at full throttle from 30 to 50 mph, then lift off the throttle completely, and allow the vehicle to slow to 30 mph with the throttle closed. Repeat the procedure 10 or 12 times. This will load the piston rings, and cause them to seat properly against the cylinder walls. Check again for oil and coolant leaks.

**8** Drive the vehicle gently for the first 500 miles (no sustained high speeds) and keep a constant check on the oil level. It is not unusual for an engine to use oil during the running-in period.

**9** At approximately 500 to 600 miles, change the oil and filter.

**10** For the next few hundred miles, drive the vehicle normally - don't nurse it, but don't abuse it, either.

**11** After 2000 miles, change the oil and filter again. The engine may now be considered to be fully run-in.