

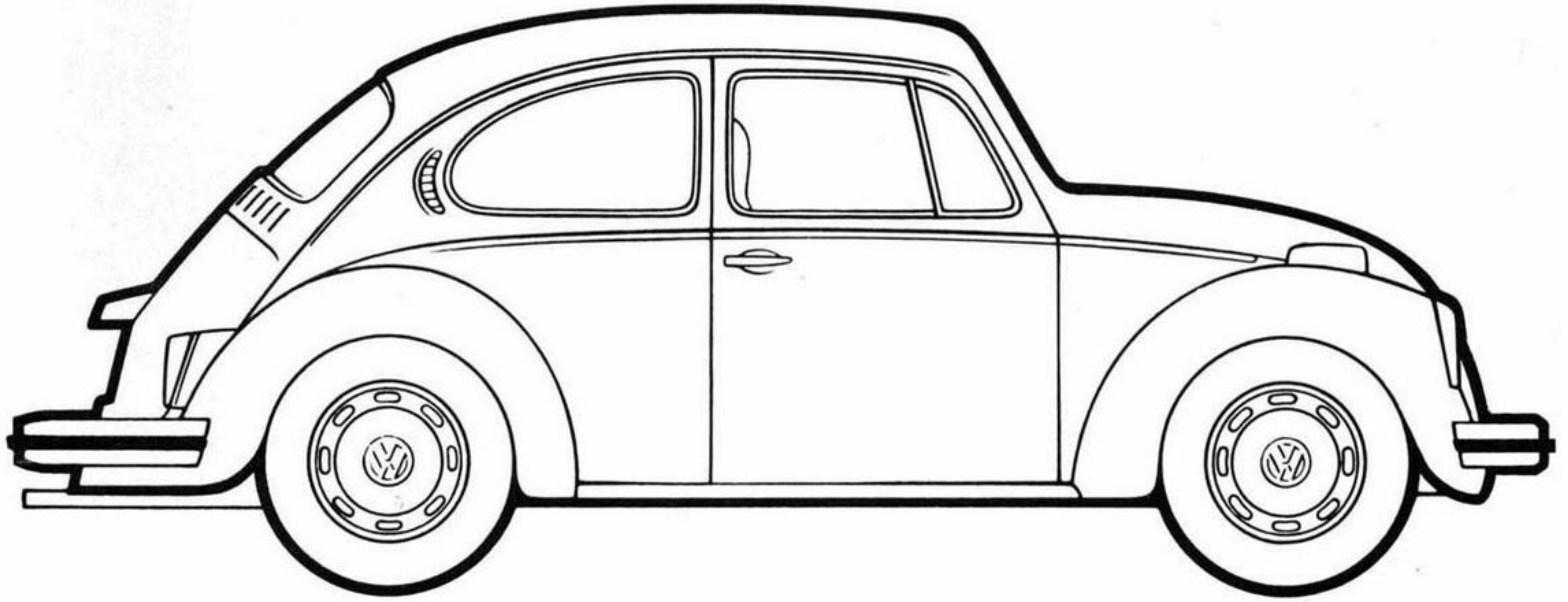

Volkswagen Owner's Manual

Beetle 1977



Volkswagen Owner's Manual

1977 Models

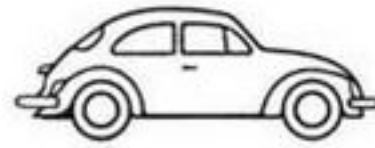

Volkswagen
Beetle

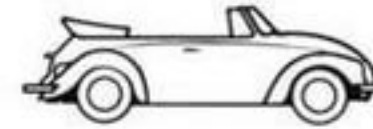

Volkswagen
Convertible

VOLKSWAGENWERK AKTIENGESELLSCHAFT

Fuel Injection Engines and Catalytic Converters

Federal and State Laws in the United States require automobiles to meet specific standards. Therefore vehicles meeting U.S. specifications may differ from vehicles normally marketed in other countries where necessary spare parts for servicing such vehicles or specific fuels may not be readily available.

Fuel injection engines

U.S. specification Volkswagen models equipped with fuel injection engines require special service facilities and parts. Such facilities and parts are not commonly available outside the United States and Canada. Since Volkswagen of America, Inc. and Volkswagenwerk AG do not recommend the sale of Volkswagen vehicles with fuel injection engines for use in areas in which adequate service facilities and parts are not available, United States specification Volkswagen models with fuel injection are not normally sold for use outside the United States and Canada.

Catalytic Converters (California only)

VW models built for California are equipped with a catalytic converter which is a major element of the emission control system. Such vehicles require **unleaded gasolines** for the engine. Deposits from leaded gasolines and fuel additives containing sulfur, zinc, nickel or barium render catalytic

converters inoperative, and thus defeat their purpose to control harmful exhaust emissions.

Since unleaded gasolines may not be available outside the United States and Canada, Volkswagen of America, Inc. and Volkswagenwerk AG do not recommend the sale of Volkswagen vehicles equipped with catalytic converters for use outside the United States and Canada.

It is important to keep your new vehicle in proper operating condition. If engine malfunction should occur, particularly involving engine misfire or other noticeable loss of performance, do not continue to operate your vehicle in that condition but promptly contact an authorized dealer. Continued operation of your vehicle with a severe malfunction could cause the catalytic converter to overheat.

As with any other vehicle, do not park or operate this vehicle in areas where combustible materials such as grass or leaves can come into contact with a hot exhaust system. Under certain conditions, these materials could be ignited by a hot exhaust system.

Should you have any questions about the use of U.S. specification Volkswagen models, which are equipped with fuel injection engines or catalytic converter in a particular country or area, we advise that you request specific information from your authorized dealer, Customer Assistance of Volkswagen of America, Inc. or Volkswagen Canada Ltd.

This Volkswagen Owner's Manual

acquaints you with the operation of your car. In your Owner's Manual you will also find information on fuel, lubrication, technical data, plus an explanation of how the emission control system works.

Read this manual before you drive your new Volkswagen. Acquaint yourself with its features and know how to operate your car more safely . . . because the more you know about it, the more you will enjoy driving your Volkswagen.

The Warranty and Maintenance

for your new Volkswagen is explained in a separate booklet. The first part of the Warranty and Maintenance booklet acquaints you with the **New Car Warranty and the Emission Control System Warranty**.

Should you have occasion to make use of your Volkswagen Warranty, it is always helpful to have the related service receipts handy.

The second part of the Warranty and Maintenance booklet deals with the **Volkswagen Computer Analysis and Maintenance**. It explains how you can keep your Volkswagen in top driving condition by having it serviced regularly.

Check the service schedule and mileage chart in the Warranty and Maintenance booklet. It will tell you when to bring your car to your Authorized Volkswagen Dealer for its periodic oil change, computer analysis and maintenance service.

Always have the Warranty and Maintenance booklet with you when you take your car to an Authorized Volkswagen Dealer for service . . . it provides your Service Adviser with the information he needs and enables him to make the necessary entries for you. So you'll have a record of all performed services.

CONTENTS

	page		page		page
Accelerator pedal	21	Dear VW Owner	6	Gearshift lever	
Air cleaner	53	Defroster	25	Glove compartment	23
Air Conditioner	31	Doors	8	Headlight switch	16
Alternator warning light	17	EGR light	17	Head restraints	10
Ashtrays	19	Emergency flasher	16	Heater	25
Assist straps and coat hooks	20	Emission Control System	62	Heater lever spot light	25
Auxiliary Heater	30	Engine number	7	Ignition/steering lock	15
Battery	34, 42	Engine oil, changing	52	Instrument illumination	16
Brake fluid reservoir	41	Engine oil, checking	51	Instrument panel	13, 14
Brakes	21, 22	Engine oil grades	55	Interior light	20
Brake warning light	15	Fan belt: adjusting or replacing	50	Jack	37
Bulb chart	47	Fuel gauge	17	Keys	8
Bulb replacing	48	Fuel injection	2	Lane changer	18
Catalytic converter	17, 23, 43	Fuel supply	42	License plate light	49
Chassis number	7	Fuses	43	Lubricants	55
Cleaning your VW	45	Gas Station Information	66	Lubrication	54
Clutch pedal	21			Luggage compartments	24
Convertible top	29				

	page
Oil pressure warning light	17
Rear seat: removing and installing	47
Rear view mirrors	20
Rear window defogger	19
Reverse	22
Safety belts	11
Seats	10, 47
Sliding roof	28
Spare wheel	36
Spark plugs: cleaning and replacing	51
Speedometer with fuel gauge and warning lights	17
Speed ranges	22
Starting hints	23
Sun visors	20
Technical data	58
Tires	35

	page
Tool kit	38
Towing and trailer hauling	33
Transmission	21
Transmission oil	53
Transmission oil grades	55
Troubleshooting	56
Turn signal/headlight dimmer switch lever	18
V-belt: adjusting or replacing	50
Vehicle Identification	7
Ventilation	27
Warning lights	16, 17
Wheel changing	38
Windows	9
Windshield washer fluid container	41
Windshield wiper/washer lever	18
Winter operation	34

Pictures and text in this manual are based on the 1977 Volkswagen Beetle. Where the controls, equipment and technical data of the Volkswagen Convertible differ considerably, we will point this out in the text.

Various items shown or described in the manual may not apply to the model you have chosen. Check with your Authorized VW Dealer on available equipment, options or accessories.

It has always been Volkswagen's policy to continuously make technical improvements; therefore, the right is reserved to make changes at any time during the model year without notice.

Dear VW Owner

A lot has gone into the manufacture of your Volkswagen. Including advanced engineering techniques, rigid quality control and demanding inspections. The engineering and safety features that have gone into your VW will be enhanced by . . . you,

the safe driver

– who knows his vehicle and all the controls,

– who maintains his vehicle properly,

– who uses his driving skills wisely.

Because safe driving is important to you, we urge you to follow the check list shown on this page whenever you use your VW.

Before getting behind the wheel:

- 1 – Make sure that the tires are inflated correctly.
- 2 – Watch the tread depth indicator on the tires. Look for bruises and wear.
- 3 – See that all windows are clean and unobstructed.
- 4 – Check that headlight and tail light lenses are clean.
- 5 – Check that all lights are functioning properly.
- 6 – Check turn signal lamps and indicator light (ignition on).

In the driver's seat:

- 1 – Position seat properly for easy reach of controls.
- 2 – Adjust inside and outside mirrors for unobstructed rear view.
- 3 – Fasten safety belts.
- 4 – Check brake warning light when starting the engine.
- 5 – Check brake operation.
- 6 – Make sure that all doors are closed securely and locked.

And when you are on the highway:

- 1 – Always drive defensively. Expect the unexpected.
- 2 – Use signals to indicate turns and lane changes.
- 3 – Turn on headlights at dusk.
- 4 – Follow at a safe distance. A good rule of thumb is to allow a minimum of one car length for each 10 mph of speed.
- 5 – Reduce speed during night hours and inclement weather.
- 6 – Observe speed limits and obey highway signs.
- 7 – When tired, get off the highway, stop and take a rest.
- 8 – When stopped or parked, always set the parking brake.
- 9 – When stalled or stopped for repairs, move the car well off the road. Set the emergency flasher and use road flares or other warning devices to warn other motorists.

Vehicle Identification

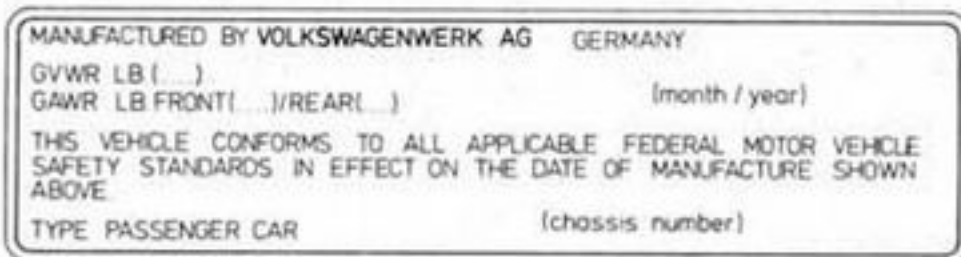

B3-078

Safety Compliance Sticker

This sticker is your assurance that your new Volkswagen complies with all applicable Federal Motor Vehicle Safety Standards which were in effect at the time the vehicle was manufactured. You can find this sticker on the left doorjamb.

The sticker also shows the manufacturer's name, the month and year of production and the chassis number of your car (perforation) as well as the **Gross Vehicle Weight Rating** and the **Gross Axle Weight Rating**.



B12-599

The chassis number

is located on the instrument panel on the driver's side so that it is visible from the outside through the windshield. This is for your protection . . . to aid in the apprehension of car thieves and the recovery of stolen vehicles.



The engine number

is stamped on the alternator support flange.

Keys

Your Volkswagen comes with two sets of keys:

The key with the elongated head (A) is for the doors and the ignition/steering lock.

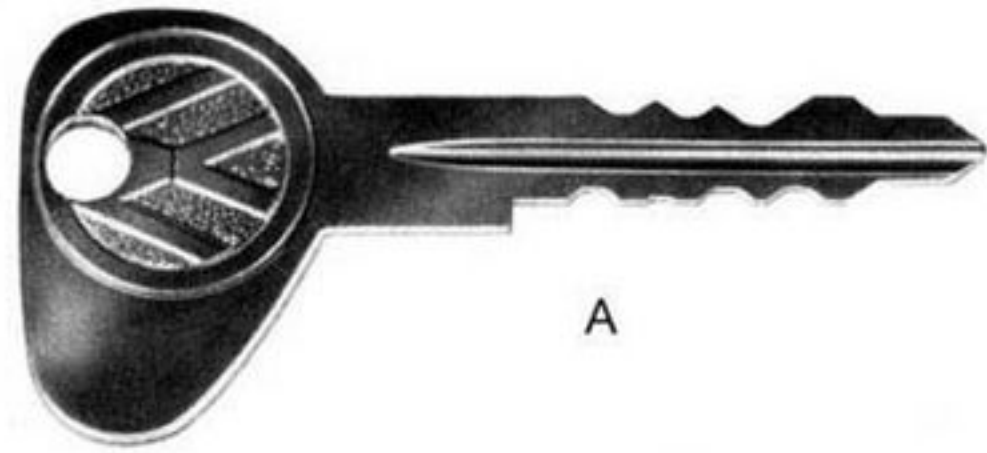

The key with the round head (B) is for the glove compartment door of the Convertible.

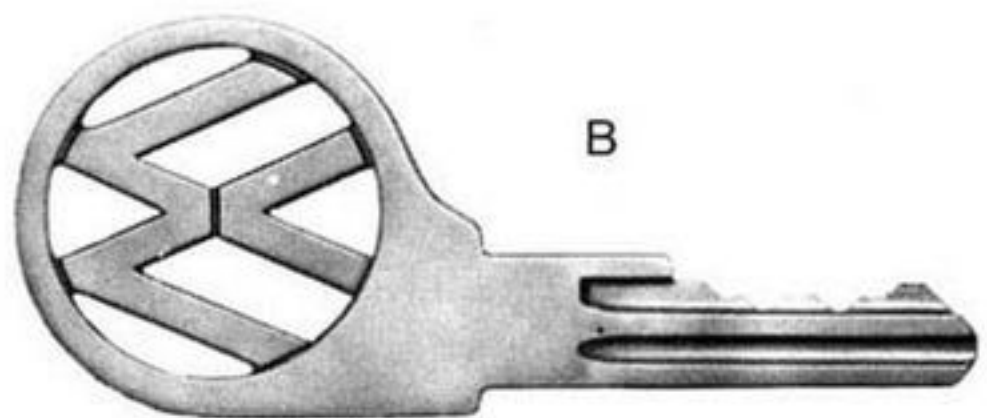

Do not invite car theft

by leaving your car unattended with the key in the ignition lock. Take the key with you and lock the doors.

A buzzer will remind you when you open the driver's door and the key is still in the ignition lock.

It is a good idea to keep a record of your key numbers in your wallet together with your license. If you should lose a key, your Authorized VW Dealer will thus be able to quickly secure a replacement key for you.

Doors

Always drive with locked doors to prevent inadvertent opening of a door from the inside, especially with smaller children in the car.

From outside

Open doors by squeezing trigger in outer door handle (1).

Lock and unlock doors with the key by turning the key to the left or right (2).

Doors can also be locked without a key. First depress locking knob (3), then squeeze trigger in outer door handle as you close door.

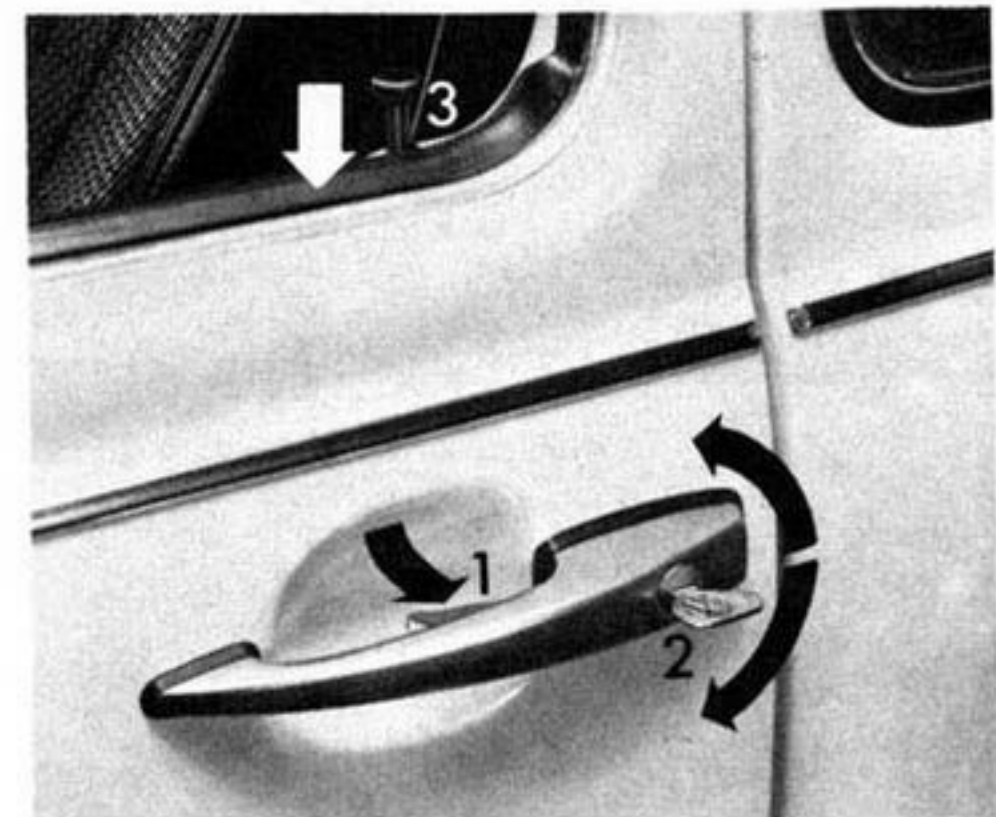

Windows

If the door, with the locking knob depressed, closes by itself, the locking knob will disengage automatically. We provided this additional safety feature so you won't be locked out if the door should slam shut while the key is still inside the car.

From inside

Lock and unlock doors by depressing or raising locking knob (3).

To open doors, pull inside door handle (4).

Since your VW is almost air-tight, it will be easier to close the door if you open a window slightly.

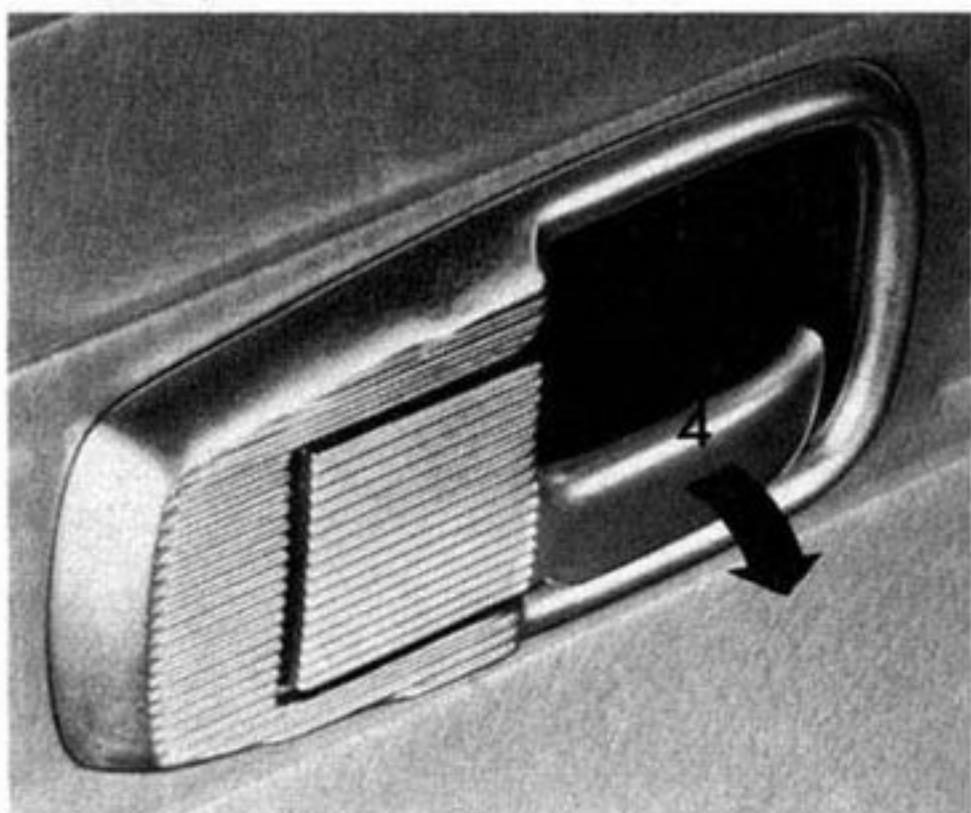

We recommend you do not put decals or other signs on the windows of your car that may interfere with the driver's vision.

You can lower and raise the windows in the doors by means of winders. We cushioned the knobs for your safety.

To open the vent window, turn knob into driving direction, move locking lever forward and push out window.

To make closing the vent window easier, we suggest you first push on the forward part of the vent window so that it fits snugly against the weatherstripping. Then grasp the knob, and move the lever back to lock it in place.

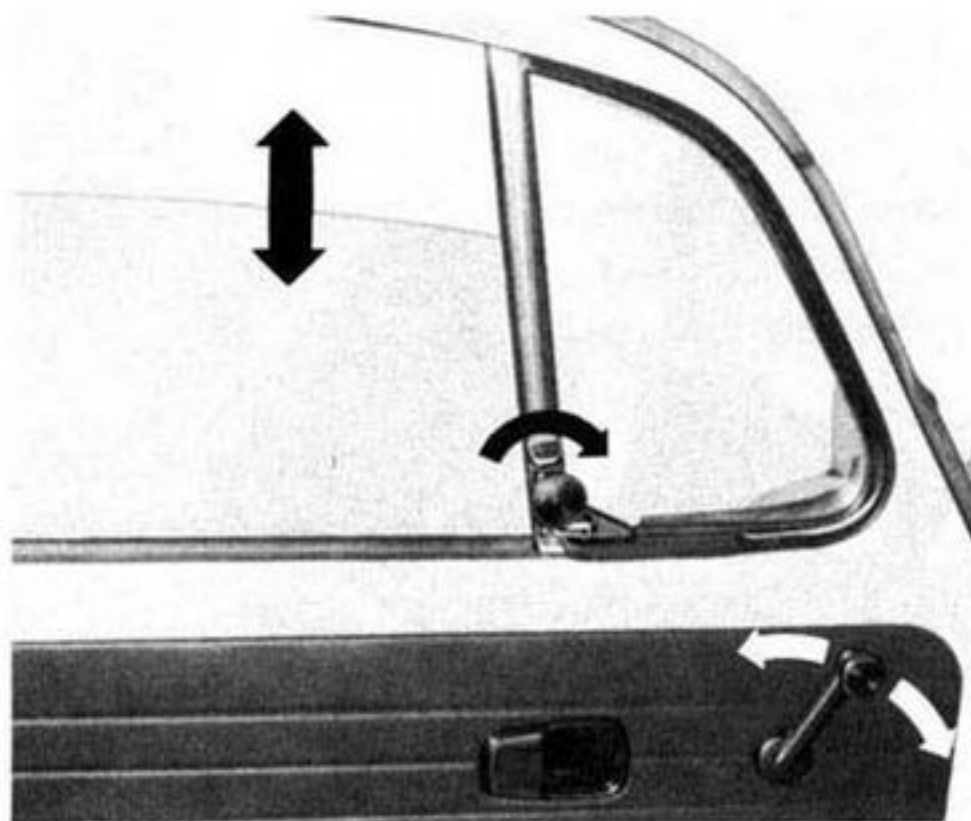

Seats

We recommend you do not adjust the driver's seat while driving. Your seat may suddenly jerk forward or backward, which could result in loss of control.

Seat adjustment

To move the seat forward and backward, pull the lever (1) in front of the seat. Now slide the seat to the desired position. Let the lever go, and move the seat slightly back and forth to make sure it is securely engaged.

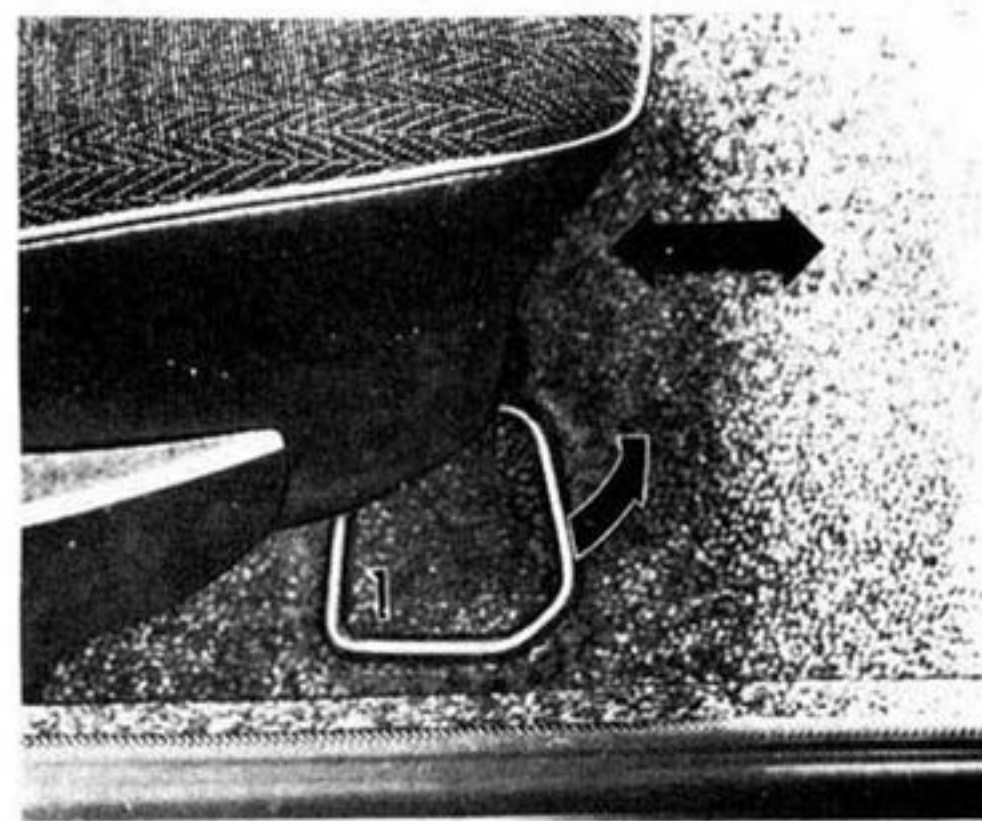

Head restraints

The padded head restraints of the front seats are fully adjustable.

To adjust height, pull head restraint up or push it down (a).

To offer maximum support, the upper edge of the restraint should be slightly higher than the level of your eyes.

To tilt restraint forward or back, grasp it firmly with both hands and move to desired position (b).

If you can touch the restraint with your head slightly to the rear, the restraint is properly adjusted.

Backrest adjustment

Front seat passengers should not ride in a moving car with the backrest reclined. Safety belts only offer protection when the backrest is in an upright driving position.

To adjust the backrest, turn the wheel at the side of the seat cushion, with your body weight taken off the backrest.

To release backrest lock

pull up the lever on the side of the backrest. Tilt the backrest forward and out of the way for easy access to the rear passenger compartment.

If the lever cannot easily be moved upward, push the backrest forward slightly as you pull up the lever.

For your and your passenger's protection, the backrest locks must be engaged at all times while the car is in motion.

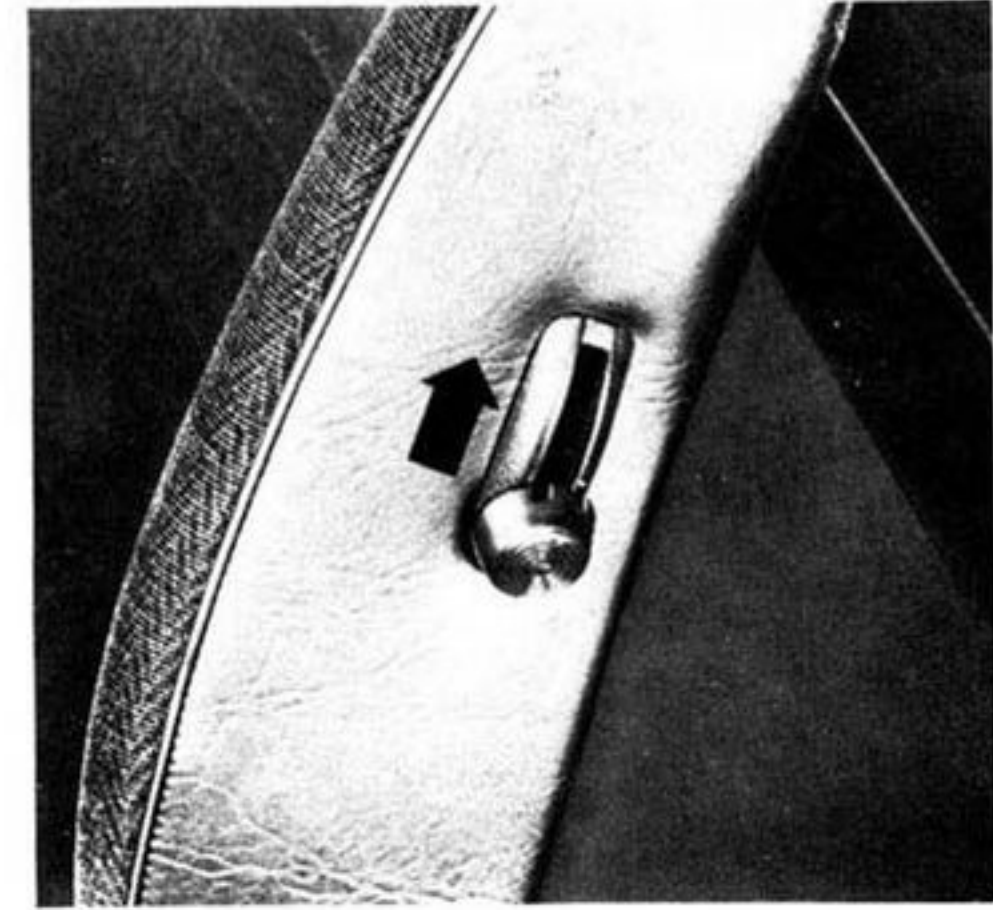
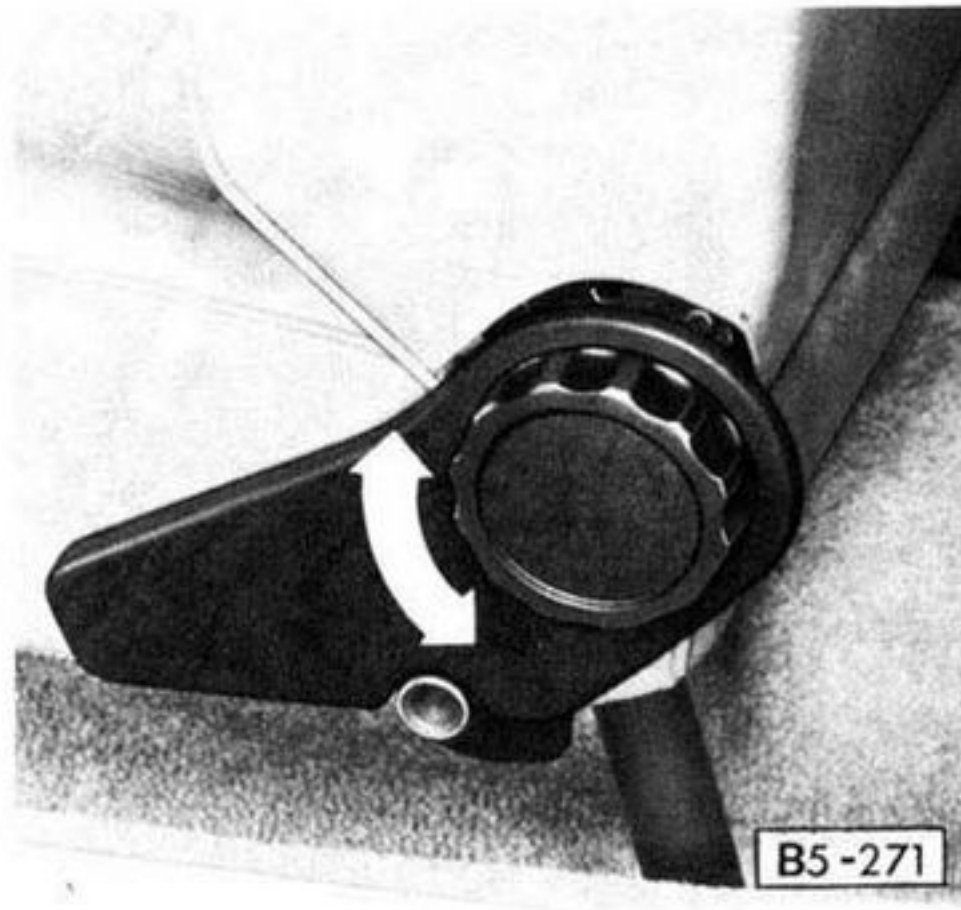
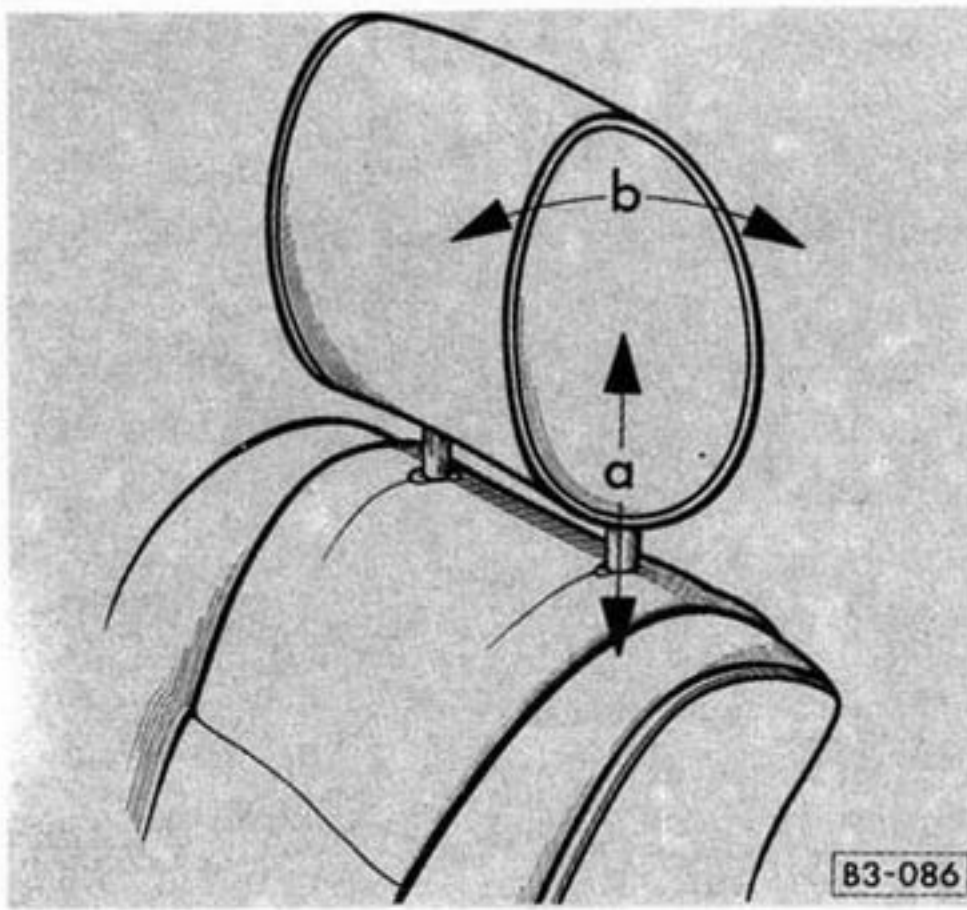

Safety belts

A safety belt is provided for each seating position in your Volkswagen.

Safety belts that were subjected to excessive stretch forces during an accident should be replaced.

Safety Belt Warning System

An audio-visual warning system is interconnected with the driver's safety belt. Every time the ignition is turned on, the FASTEN BELTS warning light on the dashboard will come on for about 6 seconds as a reminder to buckle up. If the driver does not fasten the safety belt, the buzzer will also come on for the duration of this six second period. The buzzer will go off as soon as the driver has buckled up.

For your and your passenger's protection, we recommend you wear safety belts at all times while the car is in motion.

Safety belts for front seats

The front seats are equipped with lap/shoulder belts with an automatic locking retractor. The belt adjusts automatically to your size and movements as long as the pull on the belt is slow. **A sudden motion locks the belt.** The automatic locking mechanism in the retractor will also lock the belt when driving down a steep hill or in a curve, and when the car's speed is reduced.

Do not strap in more than one person in each belt.

A shoulder belt should not be worn by a person less than 4' 7" in height, because it would not be in its most protective position, and therefore may increase the possibility of injury in a collision.

To fasten your lap/shoulder belt, grasp the belt tongue and pull the belt in a continuous slow motion across your chest and lap. Insert the belt tongue into the corresponding anchor housing on the center tunnel and push down until it is securely locked with an audible click. Pull the shoulder part of the belt to ensure that the lap part fits tightly.

Belts should not be worn twisted.

To unfasten the belt, push in the release marked PRESS on the corresponding anchor housing. The belt tongue will spring out of the anchor housing.



Safety belts for rear seats

To store the lap/shoulder belt, guide the belt tongue to its stowed position behind the assist strap on the door post. For the passenger's comfort, the retracting forces of the belt are relatively low and winding up of the belt may be slow. Make sure the belt is fully wound up on the retractor.

Make sure the belt of the unoccupied passenger seat is fully wound up on its retractor so that the belt tongue is in its stowed position on the doorpost. This reduces the possibility of its becoming a striking object in case of a sudden stop.

Do not drive with the rear seat cushion removed and the backrest folded down. In the folded-down position, the backrest may interfere with the operation of the front safety belts.

The rear seats are equipped with lap belts with an automatic retractor. If you have pulled out too much of the belt, the retracting mechanism will take up the slack until the belt fits snugly across your lap and will stay locked in this position.



To fasten your lap belt, grasp the belt tongue on the outboard side of the seat, and pull it across your lap and insert the tongue in the inboard buckle. Push in until you hear a click to be sure the belt is locked securely.

To unfasten the belt, push in the release marked PRESS in the buckle.

To store the belt, guide the belt tongue to the retractor. Make sure the belt is fully wound up on the retractor. **Belt tongue and buckle should always be kept on top of the seat for ready use. Do not permit them to get caught under the seat.**

Belt care

Keep safety belts clean. If cleaning is necessary, wash them with a mild soap solution, without removing them from the car.

Do not allow the belts to retract until they are completely dry.

Do not bleach or dye safety belts. Do not use any other cleaning agents. They may weaken the webbing.

Check buckles and retractors for proper function. Check belt webbing and bindings for damage.

Instrument panel

Beetle

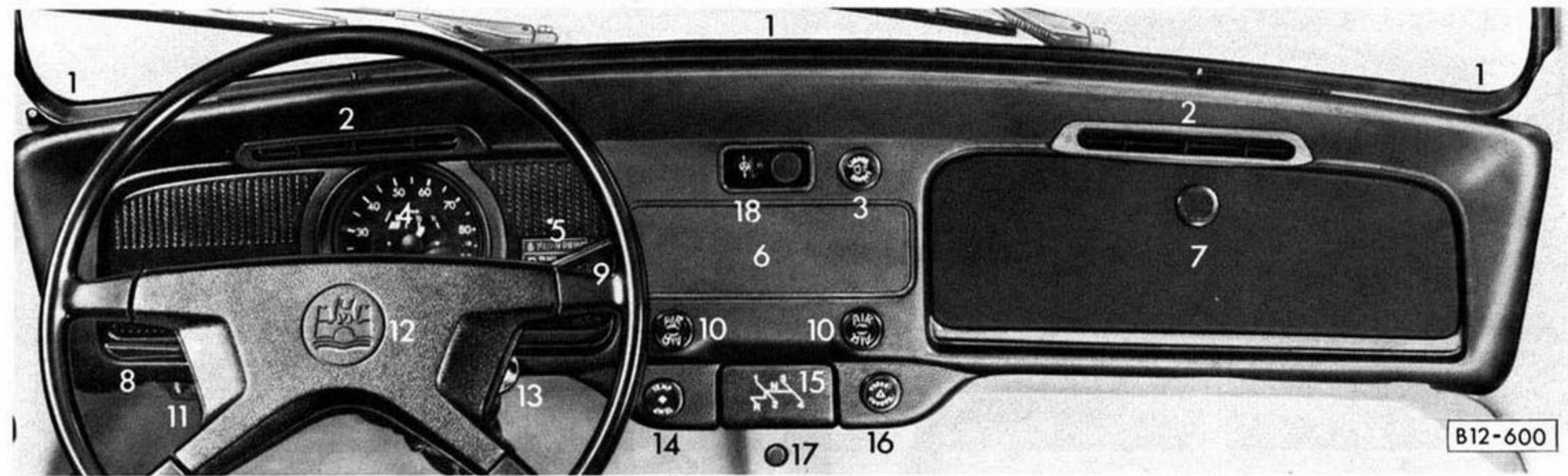

- | | | | |
|---|--------|---|----|
| 1 – Vents for heating/defrosting (there are 3). | 25 | 11 – Fuse box. | 43 |
| 2 – Vents for heating/defrosting and fresh air ventilation
(there is a pair on each side). | 25, 27 | Switch for rear window defogger. | 19 |
| 3 – Headlight switch | 16 | 12 – Horn | |
| 4 – Speedometer dial with fuel gauge and warning lights | 17 | 13 – Ignition/steering lock. | 15 |
| 5 – Safety belt and brake warning light | 11, 15 | 14 – Control knob for Auxiliary Heater
(optional equipment) | 30 |
| 6 – Plate over radio aperture | | 15 – Ashtray. | 19 |
| 7 – Glove compartment. | 23 | 16 – Emergency flasher switch | 16 |
| 8 – Turn signal and headlight dimmer switch lever. | 18 | 17 – Spot light to illuminate the heater levers between
the front seats. | 25 |
| 9 – Windshield wiper/washer lever | 18 | 18 – Knob for fresh air fan. | 28 |
| 10 – Fresh air control knobs (2). | 27 | | |

VW Convertible

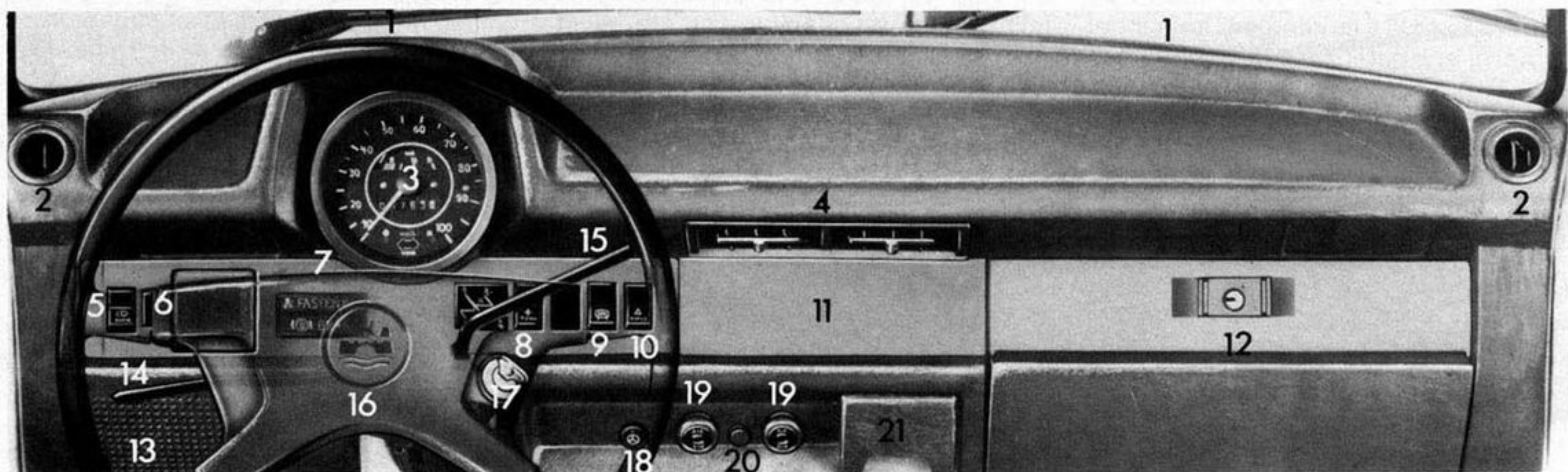

- 1 – Vents for heating/defrosting and fresh air ventilation (there are 2). 25
- 2 – Vents for heating/defrosting and fresh air ventilation for the front side windows (there is one on each side). 26
- 3 – Speedometer dial with fuel gauge and warning lights . 17
- 4 – Vents for fresh air ventilation (2) 27
- 5 – Headlight switch 16
- 6 – Instrument illumination 16
- 7 – Safety belt and brake warning light 11, 15
- 8 – Control switch for Auxiliary Heater (optional equipment) 30
- 9 – Accessory switch (open)

- 10 – Emergency flasher switch 16
- 11 – Plate over radio aperture
- 12 – Glove compartment, lockable 23
- 13 – Loudspeaker grille
- 14 – Turn signal and headlight dimmer switch lever. . . . 18
- 15 – Windshield wiper/washer lever 18
- 16 – Horn
- 17 – Ignition/steering lock. 15
- 18 – Knob for fresh air fan. 28
- 19 – Fresh air control knobs (2). 27
- 20 – Spot light to illuminate the heater levers between the front seats. 25
- 21 – Ashtray. 19

Ignition/steering lock

The steering is equipped with an anti-theft ignition lock.

For your protection, fasten safety belts. Make sure the gearshift lever is in Neutral before turning the ignition key.

1 – Ignition off/steering locked.

Insert the key. If it is difficult to turn the key, gently move the steering wheel until the key turns freely.

2 – Ignition on/steering free (for towing).

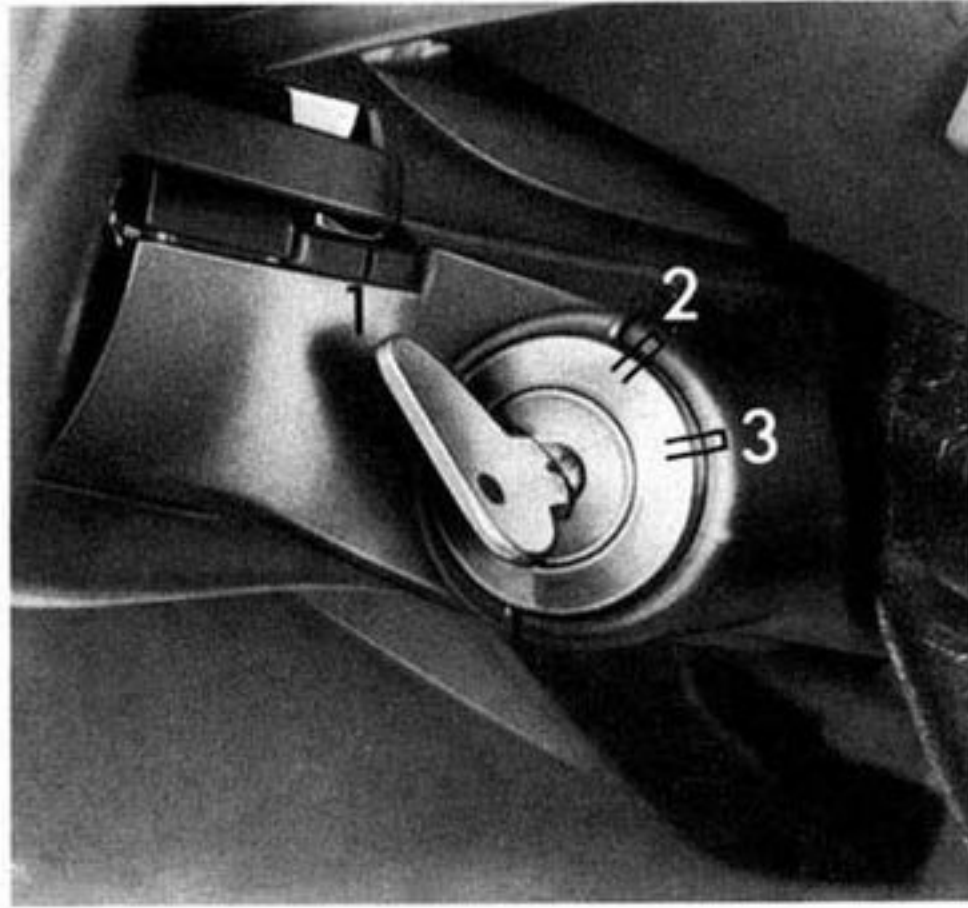

3 – Starter engages.

The key returns to position 2 as soon as it is released. Never operate the starter longer than a few seconds. If the engine should fail to start, turn the key back to position 1 and repeat the starting procedure. More on starting on page 23.

To remove the key and to lock the steering, turn the key back to position 1 and pull it out. Turn the steering wheel until it locks.

The steering column will lock when you remove the key. Therefore DO NOT REMOVE the key while you are driving or as the car is rolling to a stop.

If you leave the key in the ignition/steering lock, the buzzer will sound when the driver's door is opened. This is your reminder to remove the key.

Brake warning light

Your Volkswagen is equipped with a dual circuit brake system. Both circuits, one for the front brakes and one for the rear brakes, can function independently.



If the brake warning light lights up when you apply the brakes while driving, one of the two brake circuits may have failed. First make sure the parking brake is fully released.

Note

If one brake circuit should have failed, the other will still operate, but a longer distance and greater pedal pressure are required to bring the car to a halt.

Pull off the road and stop.

Try out the effectiveness of the brakes by carefully starting and stopping on the road shoulder.

If you judge that the brakes operate safely enough to take you to the nearest dealer, proceed cautiously and at low speed. If you do not feel it is safe to continue, have your car towed to the nearest dealer for repair.

Proper functioning of brake warning light

The brake warning light will light up when the ignition is turned on. It will go out after the engine has been started and the parking brake released. This is your assurance that the brake warning light functions properly.

If the brake warning light does not light up when turning on the ignition, or if it does not go out after starting the engine and releasing the parking brake, there may be a defect in the electrical system. If this is the case, contact your Authorized VW Dealer.

Emergency flasher switch

Beetle  Convertible: 

If your car is disabled or parked under emergency conditions, pull out the knob to make all four turn signals flash simul-

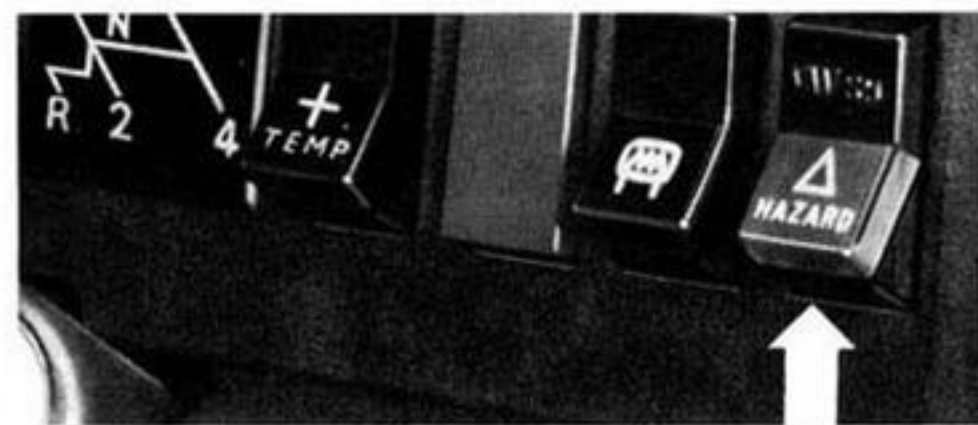



taneously (Convertible: depress the lower half of the rocker switch). The warning light in the switch flashes, too.

When the headlight switch is operated, the emergency flasher switch glows with reduced brightness for easy recognition in the dark. When the emergency flasher is not in operation, the brightness of the light can be regulated together with the instrument panel lights (see instrument illumination). The light has full brightness when the emergency flasher system is in operation.

Move the car well off the road when stalled or stopped for repairs.

Headlight switch

Beetle  Convertible: 

Pull the knob to the **first** stop (Convertible: depress the rocker switch) to turn on the parking and side marker, license plate, tail and instrument lights, emergency flasher light, spot light for the heater levers and the light in the TEMP-switch for the optional Auxiliary Heater.

Pull the knob to the **second** stop (Convertible: depress the rocker switch) to turn on the headlights (ignition on).

Note

To preserve the battery, the headlights will go out automatically when the ignition is turned off or when the engine is started.

Instrument illumination

Adjust the brightness of the instrument lights and the heater lever spot light by turning the headlight switch knob (Convertible: by turning the thumb wheel next to the rocker switch).

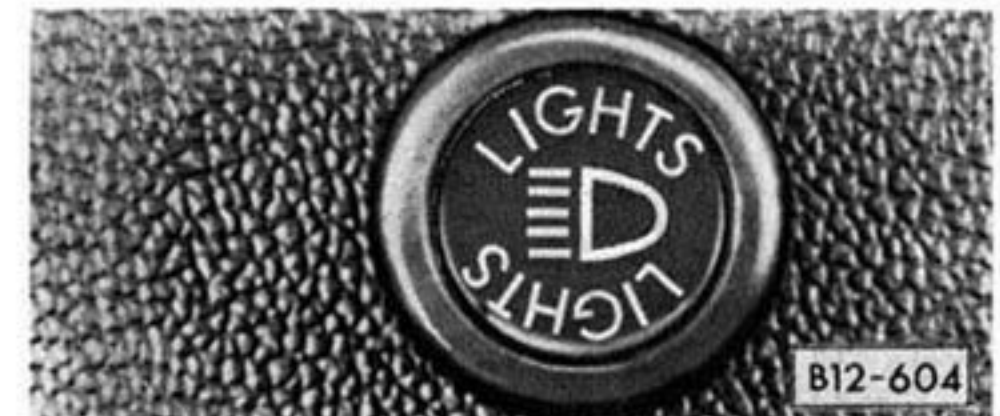

Speedometer dial

The speedometer indicates the speed; the odometer records the miles driven. The last digit in red indicates 1/10 of a mile.

The following warning lights are in the speedometer dial:

a – Exhaust gas recirculation light **EGR**

The EGR indicator lamp will light up every 15,000 miles. This is your reminder to take your car to your authorized dealer for the scheduled emission control and maintenance services.



b – Catalytic converter light **CAT** (not connected).

c – Alternator warning light

Stop at once . . .

if the alternator warning light comes on while you are driving.

Turn the engine off!

Check first whether the V-belt is slipping or broken. The V-belt not only drives the alternator but also the fan that cools the engine.

Tighten or replace the belt (see also page 57/"Troubleshooting", item F).

e – Oil pressure warning light **OIL** **Stop at once . . .**

if the oil pressure warning light comes on while you are driving.

Turn the engine off!

Check the oil level to make sure you have enough oil. If the cause is somewhere else, do not drive on but contact your nearest Authorized VW Dealer.

An occasional flickering of the oil pressure warning light when the engine is idling after a long high-speed trip is no cause for concern if the light goes out upon acceleration.

The red warning lights for alternator and oil pressure in the speedometer dial will light up when the ignition is turned on. They should go out after you have started the engine.

Whenever stalled or stopped for repair, move the car well off the road. Turn on the emergency flasher and mark the car with road flares or other warning devices. Before working on any part in the engine compartment, turn the engine off and wait until the engine has cooled down sufficiently.

Control lights **d** (turn signals) and **g** (high beam) see next page.

Control light **f** (rear window defogger) see page 19.

Fuel gauge

It is located in the speedometer dial, and only indicates the fuel level when the ignition is turned on.

When the needle is on "R", there is a reserve of about 1 gallon of fuel left in your tank . . . time to refuel at the next gas station.

Turn signal/headlight dimmer switch lever and windshield wiper/washer lever

There are two levers just behind the steering wheel:

The lever on the left side is for the turn signal/headlight dimmer switch.

The lever on the right side is for the windshield wiper/washer system.

The turn signals and the windshield wipers only work with the ignition on.

Turn signals

Lever up – right turn signal

Lever down – left turn signal

The green turn signal indicator light in the speedometer dial comes on when you operate the lever.

The turn signals are cancelled automatically when you have completed a turn (like driving around a corner), and the steering wheel returns to the straight-ahead position.

If a turn signal is defective, the control light flashes at about twice the normal frequency. Have your Authorized VW Dealer check and repair it for you.

Lane changer

To indicate your intention when changing lanes on expressways, slightly lift or depress the lever to an intermediate position. The lever will return to the OFF position when released.

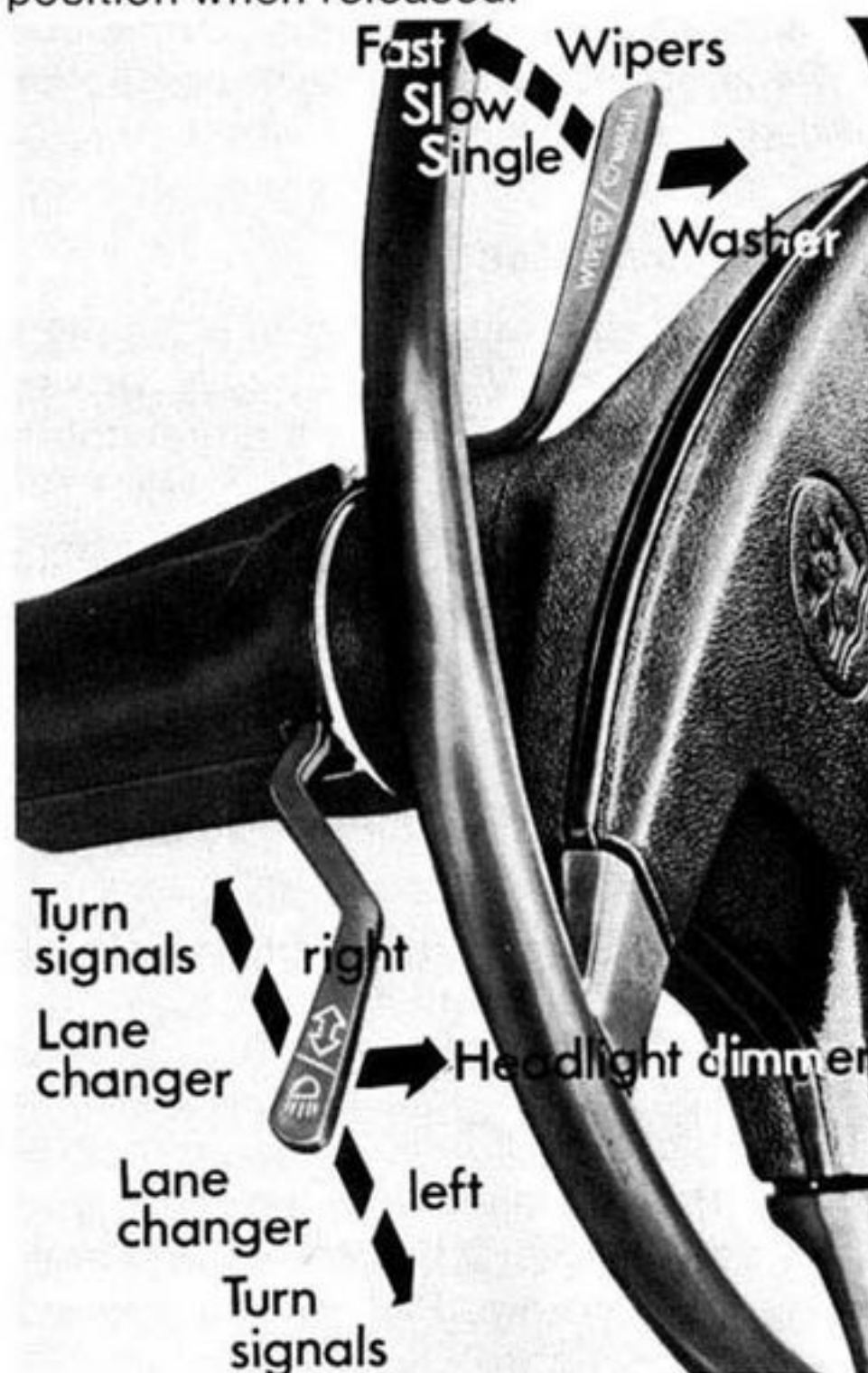

Headlight dimmer

Dim the headlights by pulling the lever toward the steering wheel. The blue indicator light in the speedometer dial will light up when the high beams are on.

Windshield wipers

The windshield wiping system operates at two speeds: low and high.

Lifting lever to first stop – low speed

Lifting lever to second stop – high speed

If you just slightly lift the lever before reaching the first stop, the wipers will wipe as long as the lever is held in this position and come to a stop when released.

To give you full battery power while starting the engine, operating windshield wipers will stop automatically at this moment.

Windshield washer

To spray washer fluid on the windshield, pull the lever toward the steering wheel. You can operate the washer from any selected wiping position.

Avoid running the wiper blades over a dry windshield . . . you may scratch the glass. Spray washer fluid on it first.

WIPE

WASH

Rear window defogger



The rear window defogger – together with the flow-through ventilation – will help to keep the inside of the rear window clear of condensation and frost in the winter.

Turn the ignition on first before you switch on the rear window defogger.

Depress the rocker switch under the dashboard to turn on the rear window defogger. The green control lamp in the speedometer dial (Convertible: in the switch) will light up to remind you that the defogger is switched on.

Beetle

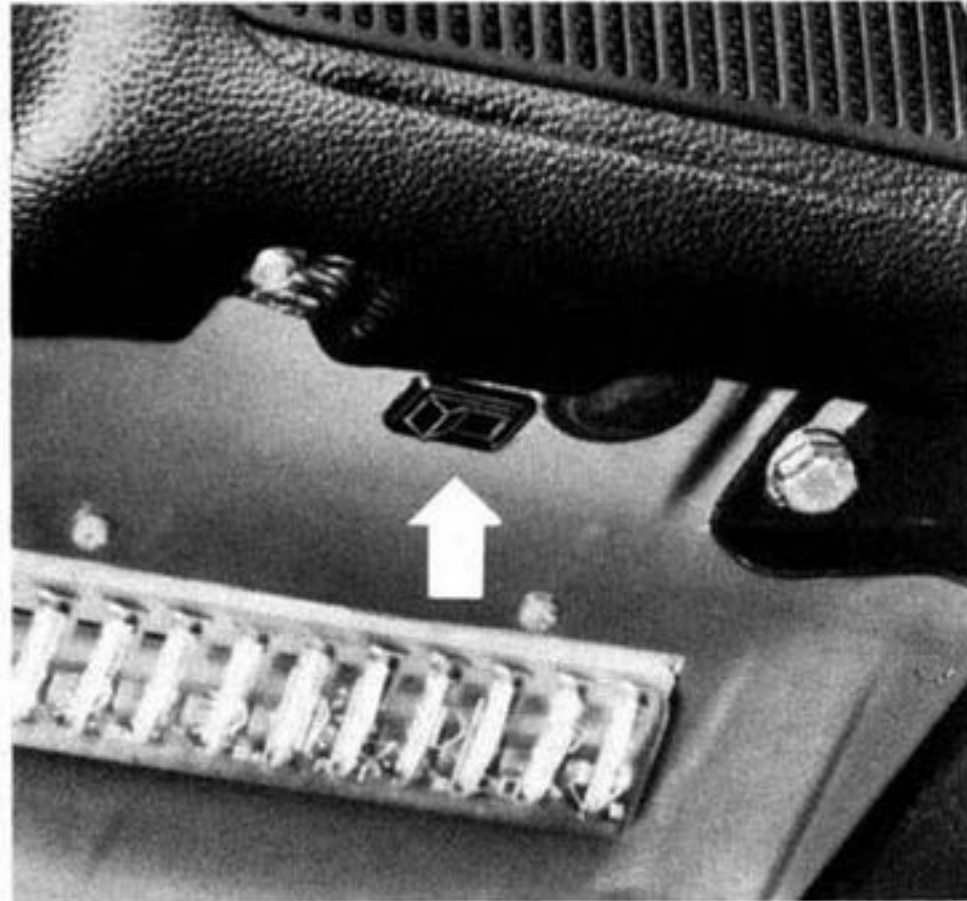

To give you full battery power while starting the engine, the operating rear window defogger will turn off automatically at this moment.

After the rear window has been cleared, switch off the rear window defogger to avoid an unnecessary drain on the battery.

Be careful when removing objects from the luggage compartment behind the rear seat. Sharp edges may damage the defogger in the rear window.

Convertible



Ashtrays

Front ashtray (picture)

Pull to open the ashtray in the instrument panel. To remove the tray, depress the leaf spring which you see just beneath the top cover. Now pull out the tray.

To put it back in, fold the top cover down, insert the tray in the guide rails and push in with the heel of your hand.

Rear ashtray

To remove the ashtray in the rear passenger compartment, press down on the tray and pull out. To reinstall, just push the ashtray back in again.



Assist straps and coat hooks

There is one assist strap and one coat hook on each side on the door post.

Hang clothes in such a way that they do not impair the driver's vision.

Interior light

The switch positions are

- Up – ON (with doors open)
- Center – OFF
- Down – ON (with doors closed)

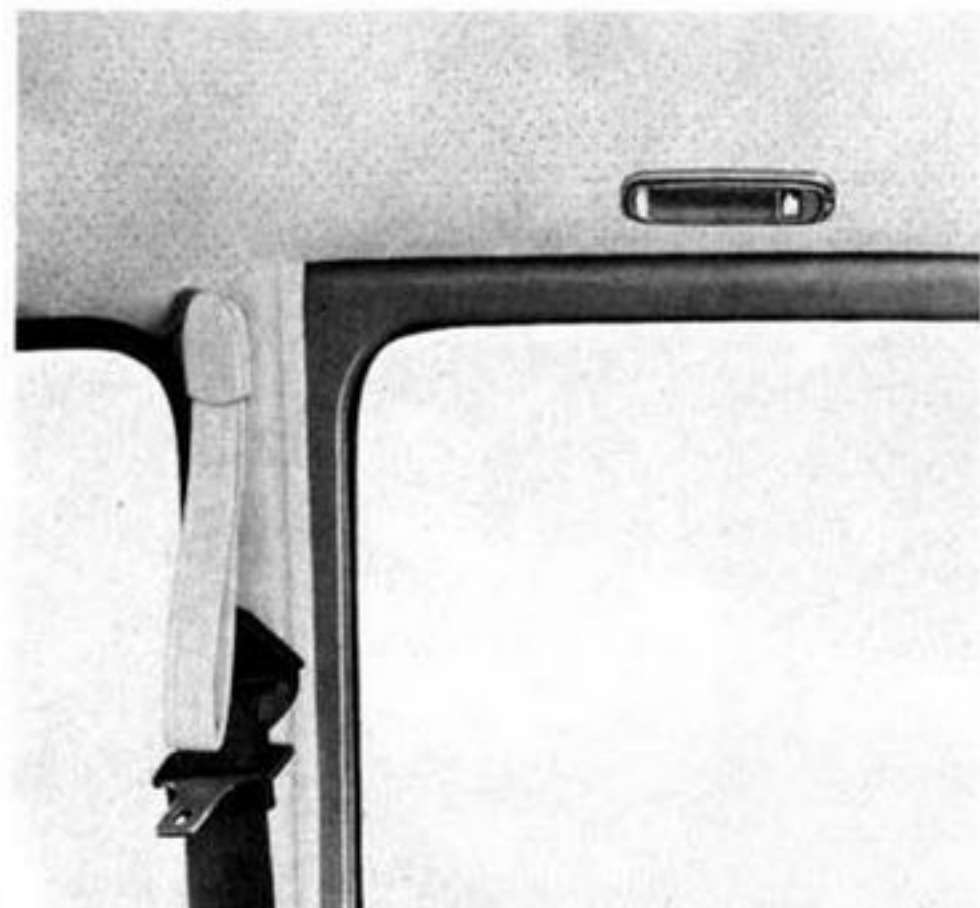

On the **VW Convertible**, the light and light switch are on the mirror bracket.

The switch positions are

- Left – ON (with doors open)
- Center – OFF
- Right – ON (with doors closed)

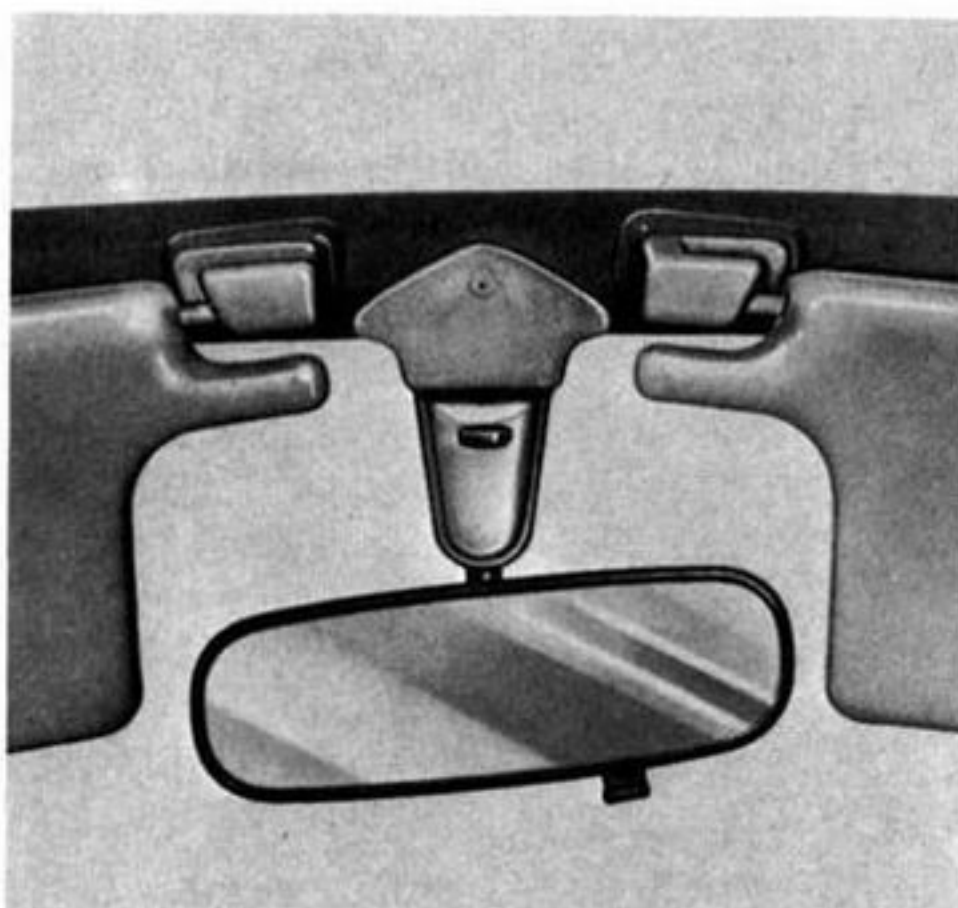

Sun visors

To protect the driver from side glare, the sun visor on the driver's side can be moved toward the door window after lifting it out of its center mounting. **The sun visor on the passenger's side cannot be moved toward the side.**

Rear view mirrors

Adjust the outside and inside mirrors before driving off. It is important for safe driving that you have good vision to the rear.

Outside mirror

The outside mirror is hinged and folds flat against the car when struck from either direction.

Inside day-night mirror (Convertible only)

You can move the day-night mirror from clear daylight visibility to non-glare visibility at night by adjusting the lever upward or downward at the bottom of the mirror.

Hand and foot controls

1 – Clutch pedal

Always depress the clutch pedal fully when changing gears. Do not hold the car on a steep hill with the clutch pedal partially depressed. This may cause premature wear or damage.

2 – Brake pedal

Make it a habit to check the operation of your brakes. You will remember from page 15 that the brake warning light will alert you if one brake circuit should have failed.

Make sure that the movement of the brake pedal is not obstructed by a floor mat or any other object.

Volkswagen automobiles have excellent brakes, but they are still subject to wear ... depending on how the brakes are used. If you find that the brake pedal travel has increased, have the brakes adjusted; if necessary, between the specified maintenance intervals.

Keep in mind that the braking distance increases very rapidly as the speed increases. At 60 mph, for example, it is not twice but four times longer than at 30 mph. Tire traction is also less effective when the roads are wet and slippery. Therefore, always maintain a safe distance.

Driving through deep water may reduce tire traction. Moisture on the brakes may also affect braking efficiency. Cautiously apply the brakes for a test. If you notice a lag in the braking action, the brakes may be wet. They will dry after you have applied the brakes a few times, but do it very cautiously.

Brake linings may not have the highest possible braking efficiency when new. Therefore allow for longer braking distance during the initial 100 to 150 miles.

3 – Accelerator pedal

For good fuel economy we recommend smooth and even acceleration.

Very fast, racy driving, alternating between full throttle and hard braking, raises the fuel consumption considerably. Also, tires and brake linings wear faster.

You can drive most economically between:

- 12 and 28 mph in 2nd gear
- 22 and 44 mph in 3rd gear
- 31 and 62 mph in 4th gear

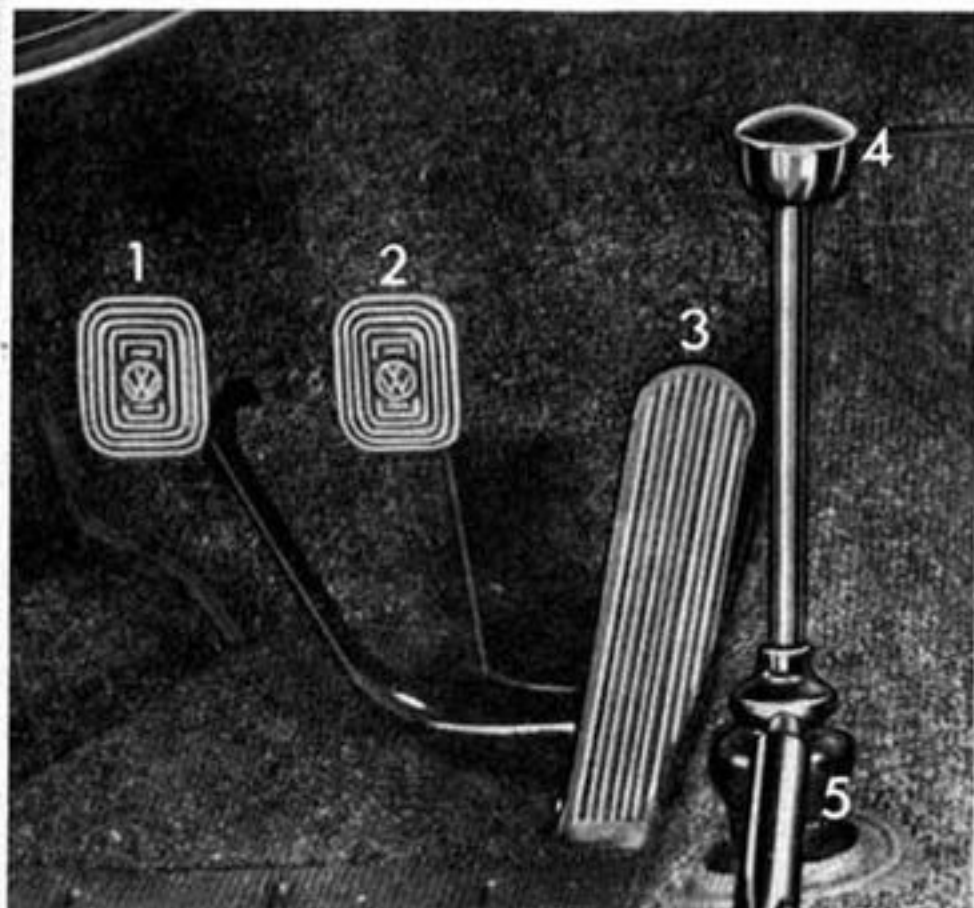

4 – Gearshift lever

The Manual Transmission is fully synchronized. The four forward gears and a reverse gear are arranged as illustrated. The shift pattern is also shown on the face of the ashtray below the dashboard (Convertible: on the instrument panel below the speedometer).

Resting your hand on the shift lever knob while driving will cause premature wear to the transmission.

Speed ranges

You can drive your Volkswagen at full speed from the first day; there is no break-in schedule. There are, however, certain recommended speed ranges for the various gears:

1st gear	0–16 mph
2nd gear	11–34 mph
3rd gear	22–56 mph
4th gear	from 31 mph up

If you have a traffic situation where it is necessary for you to overtake rapidly, you can accelerate, for a brief period only, up to

37 mph in 2nd gear

22 62 mph in 3rd gear

Reverse

Only shift into Reverse when the car is not moving. To engage the reverse gear, press the lever down, move it to the left and pull back.

The back-up lights go on automatically when you engage the reverse gear (with the ignition on).

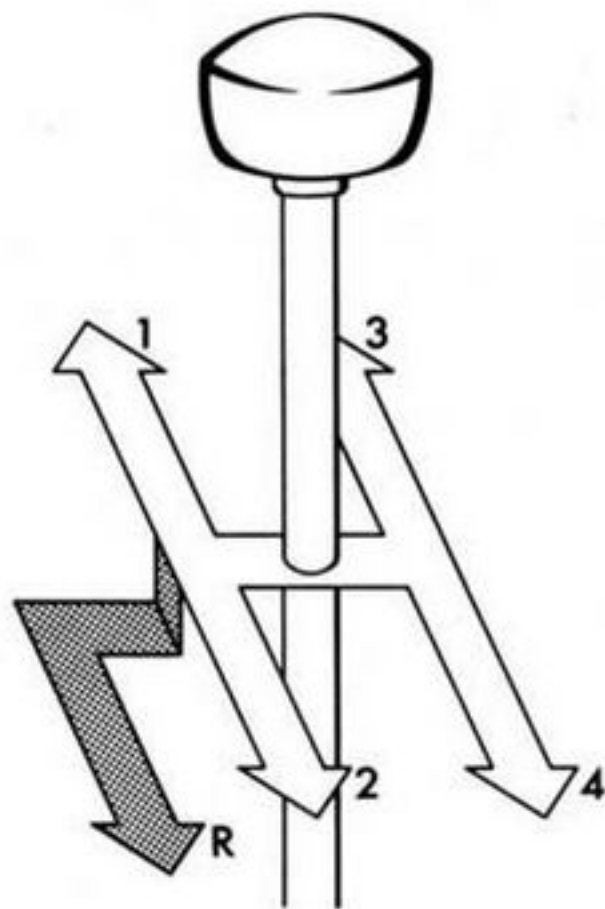

5 – Parking brake lever

To **set** the parking brake, press in the release button at the end of the lever as you pull up the lever. The parking brake is engaged as soon as you release the button on the raised lever.

With the ignition switched on, the brake warning light in the instrument panel lights up and goes out as soon as the parking brake is released (see page 16).

To **release** the parking brake, pull the lever slightly up as you depress the release button. Then push the lever all the way down.

Be sure it is fully released, because a partially engaged parking brake promotes wear of the brake linings.

Do not remove the key from the steering lock while the car is rolling to a stop. The steering column is locked as soon as you remove the key. Take out the key only after the car is parked.

Always set the parking brake when parking your car. On steep hills also turn the wheels toward the curb.

Starting hints

Never start or let the engine run in an enclosed unventilated area. Exhaust fumes from the engine contain carbon monoxide which is a colorless and odorless gas. Carbon monoxide can be fatal if inhaled.

For your protection, wear safety belts at all times while the car is in motion.

Before turning the ignition key, make sure the gearshift lever is in **Neutral**.

It is not necessary to depress the accelerator pedal when starting. This holds true for a cold engine and an engine at operating temperature no matter what the outside temperature is. The electronic fuel injection system, with which your Volkswagen is equipped, automatically supplies the required amount of fuel for starting.

Operate the starter for a few seconds only.

As soon as the engine starts, release the ignition key.

If the engine does not start the first time or stalls, turn the ignition key all the way to the left and restart.

The red warning lights for oil pressure and alternator in the speedometer dial and the brake warning light will light up when the ignition is turned on. The oil pressure and

alternator warning lights should go out after you have started the engine. The brake warning light should go out after releasing the parking brake.

It is not necessary to warm up the engine by letting it idle with the car stationary . . . drive off immediately and maintain moderate speed until the engine is warm.

Winter starting

Depress the clutch pedal when starting so that the starter only has to crank the engine.

Cars with catalytic converter

If your Volkswagen is equipped with a catalytic converter as part of the emission control system, the following is important to know:

After the engine is warmed up (not during or shortly after engine start-up) a malfunction in the ignition system, caused by a faulty spark plug for instance, could reduce the effectiveness of the converter. To keep the converter operating properly, we advise you to slow down immediately if you should notice a sudden interruption in the pull of the engine under normal acceleration. This interruption could be for brief moments or of longer duration. Drive slowly (with half or less throttle) to the nearest VW dealer or other qualified workshop to have your ignition system checked and if necessary corrected.

Glove compartment

To open the glove compartment door, turn the knob to the left.

To close the door, press until lock engages.

On the **Convertible** open the door by squeezing both plungers together. To lock or unlock the door turn key to right or left.

Inside the glove compartment is the **release for the front hood**. A locked glove compartment prevents unauthorized access to the luggage compartment and the spare wheel.

Beetle



Convertible

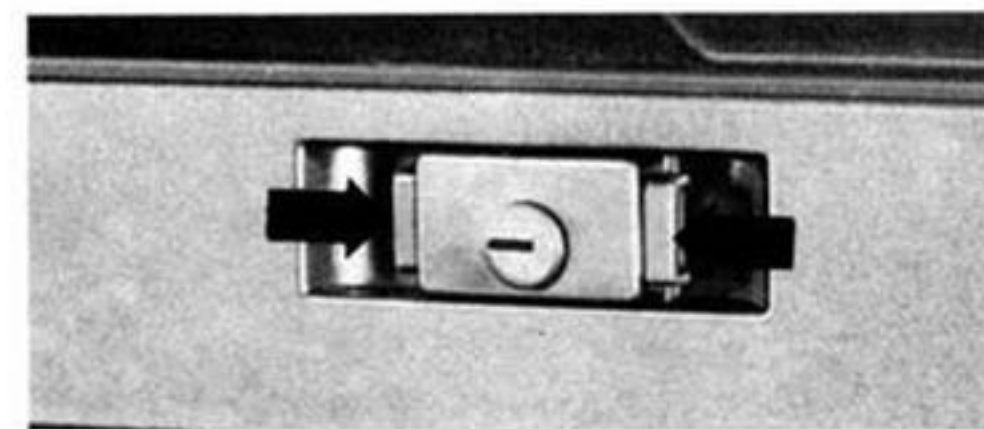

Luggage compartments

Your VW has two luggage compartments, one under the front hood, and the other behind the rear seat.

Since improper weight distribution can affect car handling, take advantage of the two luggage compartments. Load the front luggage compartment first, using the heaviest pieces of luggage, if possible.

Front luggage compartment

To **unlock** the front hood, pull the release inside the glove compartment.

Now open the front hood by depressing the release button in the hood handle.

To **lock** the front hood, lower the hood and press the handle down firmly. Do not press on one side of the hood. Make sure the hood is securely locked.



Rear luggage compartment

Additional luggage can be stored in the space behind the rear seat. You can expand this luggage area by folding the backrest down and fastening it in this position.

To **release** the backrest, pull the strap on the left, as seen in driving direction. When you fold the backrest back, it locks automatically in its place.

After folding the rear seat forward to increase the loading area, make sure the front seats and seat backs are in securely latched positions.

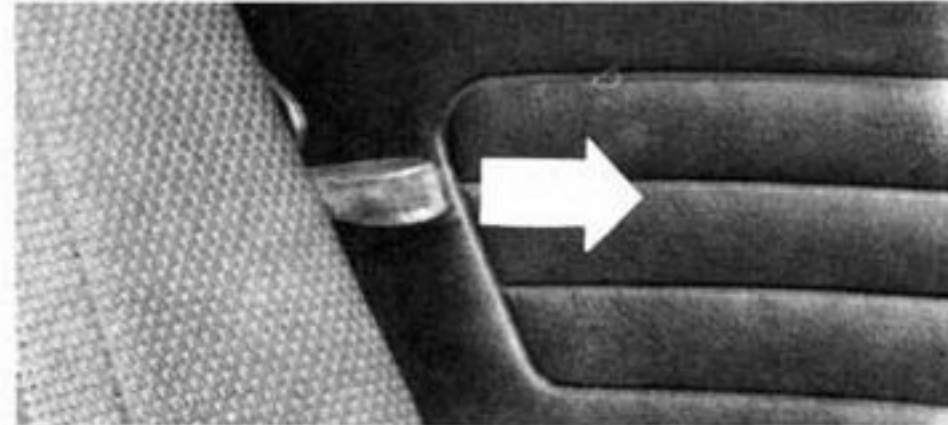

Do not drive with the rear seat cushion removed and the backrest folded down. In the folded down position, the backrest may interfere with the operation of the front safety belts.

To **hold** the backrest in the folded-down position, hook the retaining strap (on the back of the backrest) under the seat rail.

To **adjust** the length of the strap, unhook the strap and move the slide.

A – to shorten the strap
B – to lengthen the strap

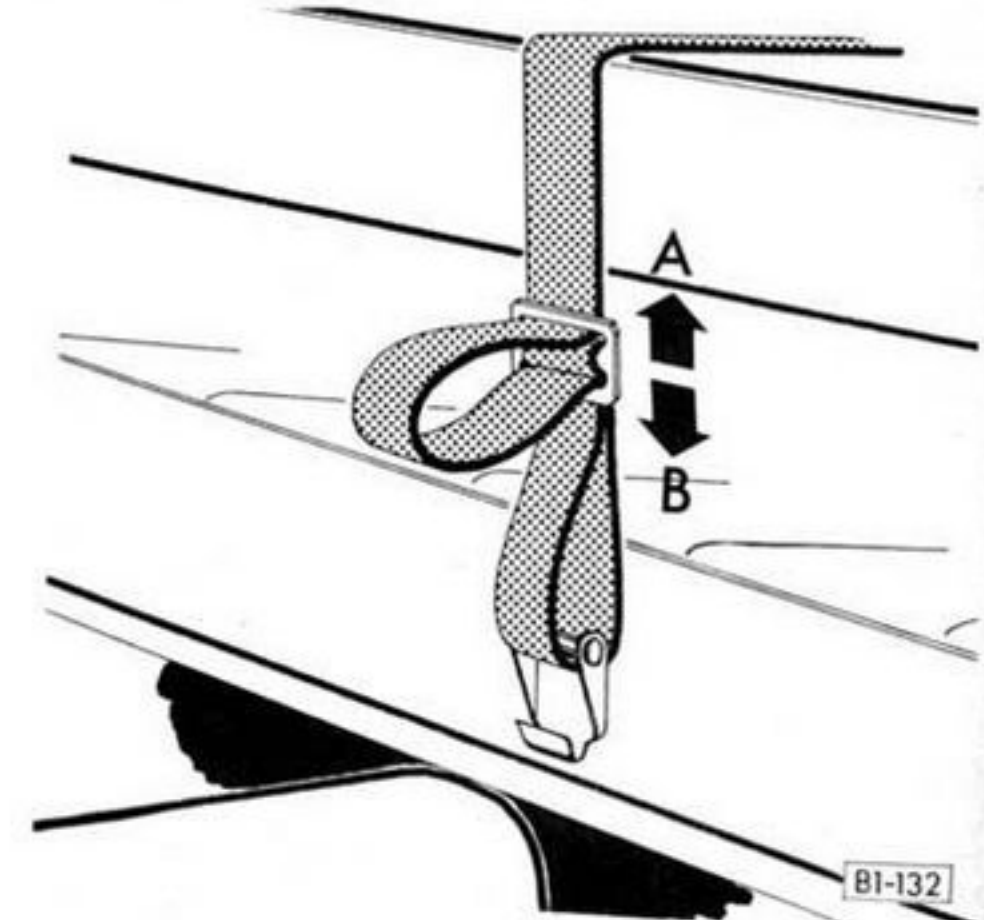

Heater/Defroster

Articles stored in the luggage area behind the rear seat can be concealed from the outside view by a **cover**. This cover is attached with hinges to the backrest.

To make use of the cover, release the backrest and fold it forward. Lift the cover up. Then move backrest and cover back. The cover will rest on the edge below the rear window. Press the backrest back to lock it in place.

We recommend you do not place articles on the cover. Such items may become dangerous projectiles when dislodged during a sudden stop. They may also reduce the driver's vision to the rear.

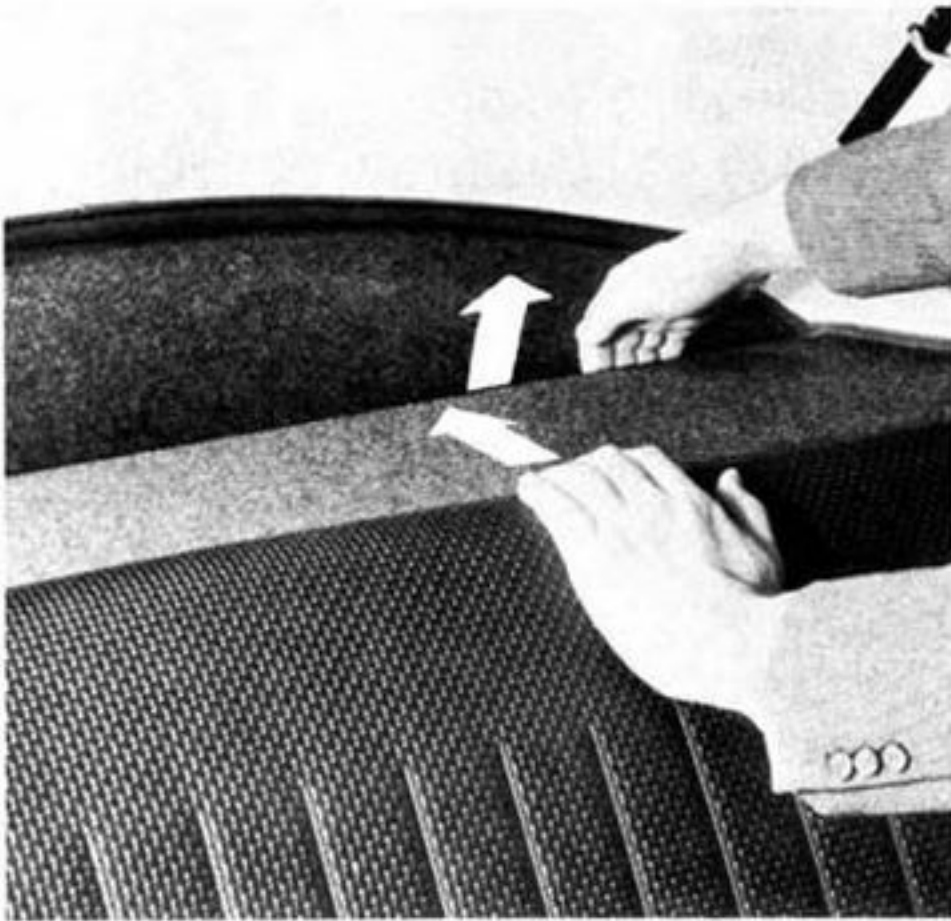

A fresh air heater/defroster is standard equipment on your Volkswagen. The control levers are located on the tunnel between the front seats. The heater lever spot light will illuminate the levers when the parking or headlights are turned on.

The brightness of the spot light and instrument illumination can be adjusted by turning the light switch knob (Convertible: thumb wheel next to the light switch). See also page 16.

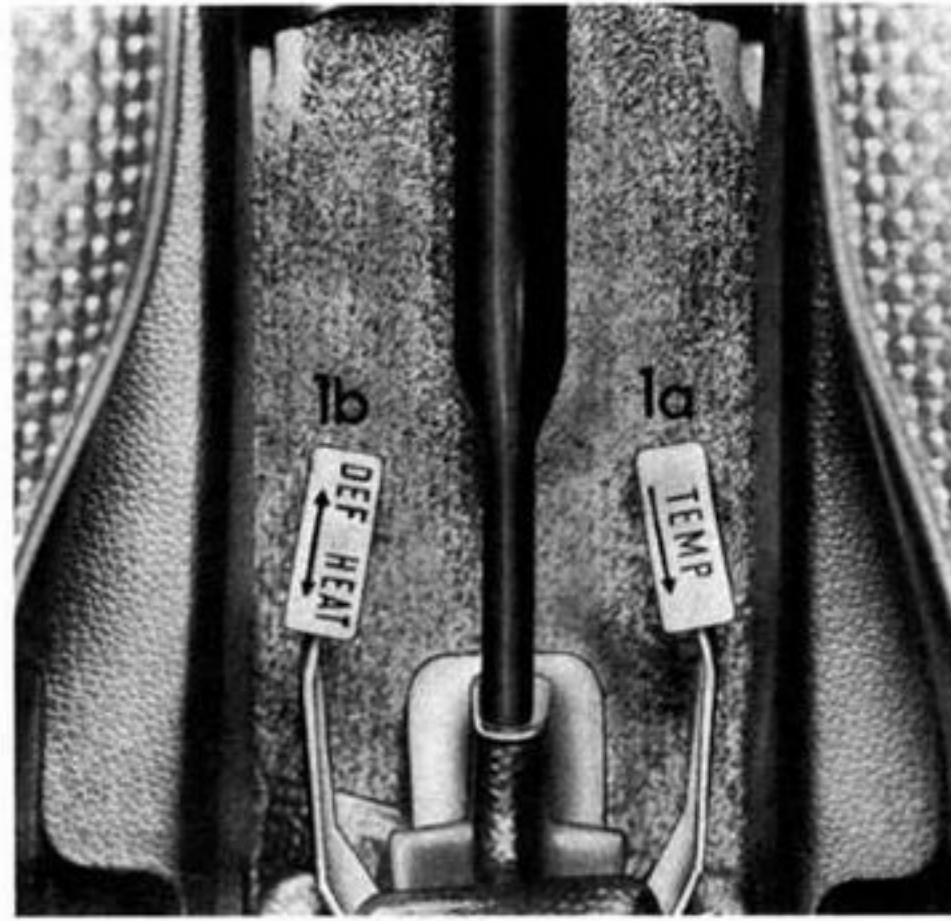

1 a – Heater temperature lever (TEMP)

The lever toward the passenger's seat controls the temperature level.

Lever up – heat on fully

Lever down – heat off

By setting it at any intermediate position, you can select the degree of heat that is most comfortable for you.

After a reasonable warm-up time, which also depends on the speed of the car, warm air will enter the car's interior through the windshield vents –1–, the heater/defroster vents – 2a – below the windshield (Convertible: side window vents – 2 –) and outlets in the front and rear footwells.

Footwell outlets

There are four footwell outlets, two in the front and two in the rear. The front outlets are located just beneath the doors, the rear outlets are under the rear seat. Front and rear footwells are opened and closed with the heat distribution lever –1b–.

1b – Heat distribution lever for front and rear footwells (DEF-HEAT)

With the lever on the tunnel next to the driver's seat you can control the distribution of heat to the front and rear footwells.

Lever down – front and rear footwells closed

Lever up – front and rear footwells fully open

You can select any intermediate position to regulate the distribution of heat to the front and rear footwells.

2 – Defroster vents for front side windows

(Convertible only)

Volume and direction of the air coming from the outlets on the dashboard can be controlled separately by adjusting the flaps in the outlets. When the flaps are closed, the entire volume of warm air flows through the vents at the windshield (– 1 –).

Beetle



Convertible

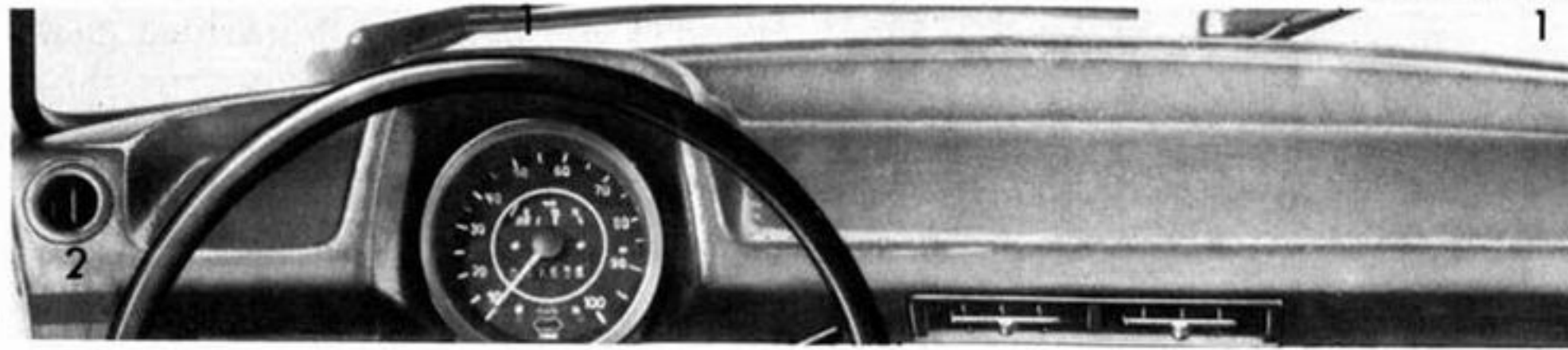

Hints for defogging and defrosting

Defogging and defrosting your windshield will be more effective if you direct the total air flow toward the windshield.

Here is what to do:

1. Heater temperature lever – 1a – all the way up (TEMP) – heat is on.
2. Heat distribution lever – 1b – all the way down (DEF) – no heat to the front and rear footwells.
3. Set the levers in the vents – 2a – below the windshield straight up. (Convertible: open the flaps in the front side window vents – 2 –).

For defogging purposes it may be advisable to add fresh air to the warm air flow:

4. Turn both fresh air knobs – 10 – (Convertible: the left fresh air knob – 19 –) to the left (see next page) and turn on the fresh air fan – 18 – (see page 28).

Now all air is directed toward the windshield (Convertible: and to the front side windows).

Ventilation

Flow-through ventilation provides a continuous draft-free exchange of air while driving. Air enters the car through the grille on the front hood and inside vents. A water separator prevents rain from entering.

The air in the passenger compartment is drawn out through inside openings near the rear window and escapes to the outside through louvers.

A two-speed electric fan behind the instrument panel increases the flow of air when driving at low speeds and also supplies fresh air when the car is standing still (ignition on).

Beetle

10 – Fresh air control knobs

You can regulate the volume of fresh air for each side separately by turning the knobs.

Turn left – air flow increases

Turn right – air flow decreases

a = on b = off

To stop the air flow completely, turn the knobs to the right beyond the pressure point.

2a and 2b – Fresh air vents

Fresh air comes out through a pair of vents on each side.

Each upper vent has a lever. When the lever is in the straight-up position the air is directed toward the windshield. In the down position (move lever to the right), the air is directed into the passenger compartment. Air will flow in both directions when you select an intermediate position.

Beetle

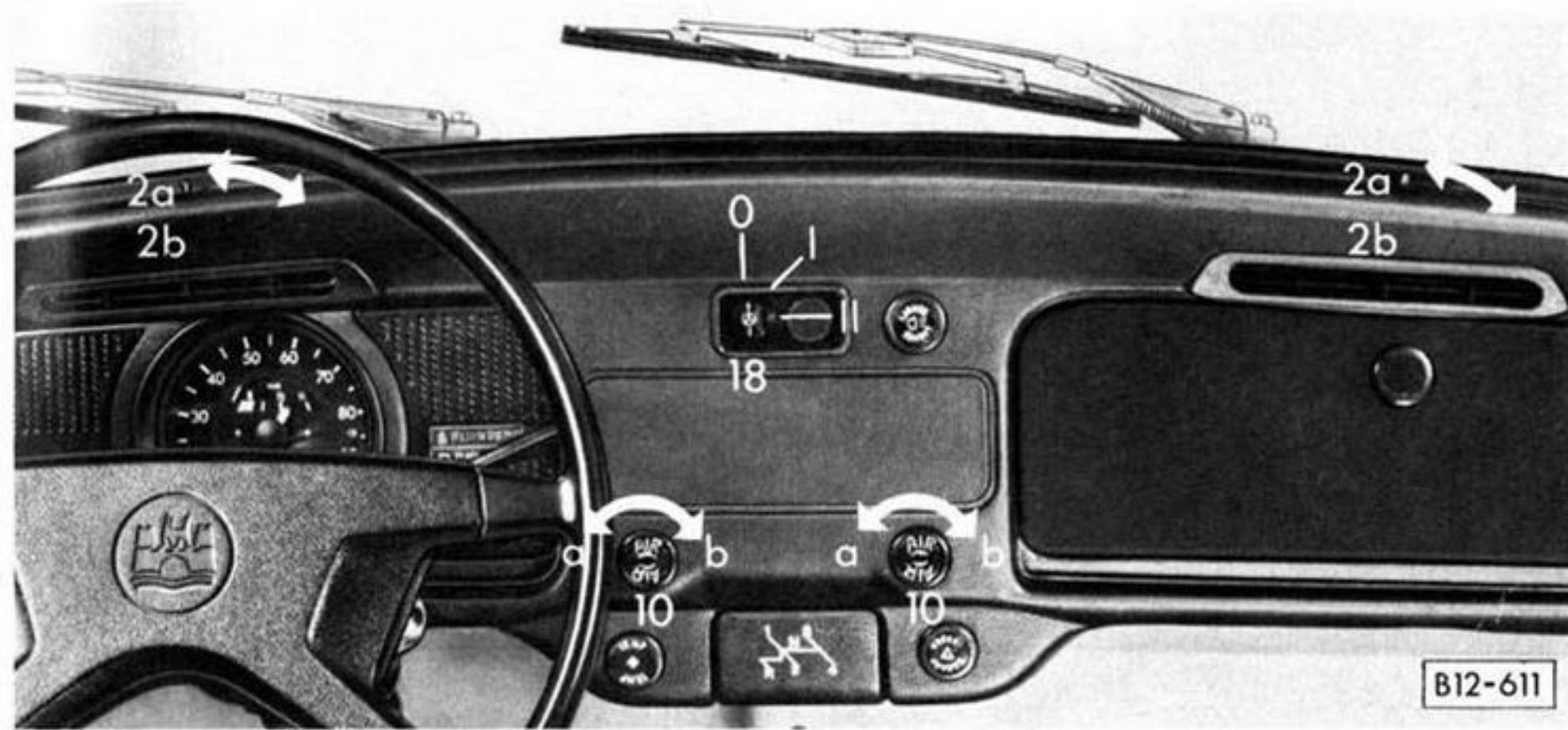

Convertible

19 – Fresh air knobs

You can regulate the volume and distribution of fresh air with the two knobs.

Left knob – turn to left:

Air flow to windshield vent –1– and side window vents –2– increases.

Right knob – turn to left:

Air flow toward passenger compartment increases (vents –4–). The vanes in the 27

vents can be adjusted upward, downward or sideways.

To **decrease** the air flow, turn the knobs to the right.

To **stop** the air flow completely, turn the knobs to the right beyond the pressure point.

Beetle and Convertible

18 – Fresh air fan

You can increase the regular air flow by turning on the two-speed fan.

Convertible

The switch positions are:

0 – off

I – low speed

II – high speed

The fan operation is most effective if you have opened the fresh air vents by turning the fresh air knobs all the way to the left.

To give you full battery power while starting the engine, the operating fresh air fan will stop automatically at this moment.

a = on b = off

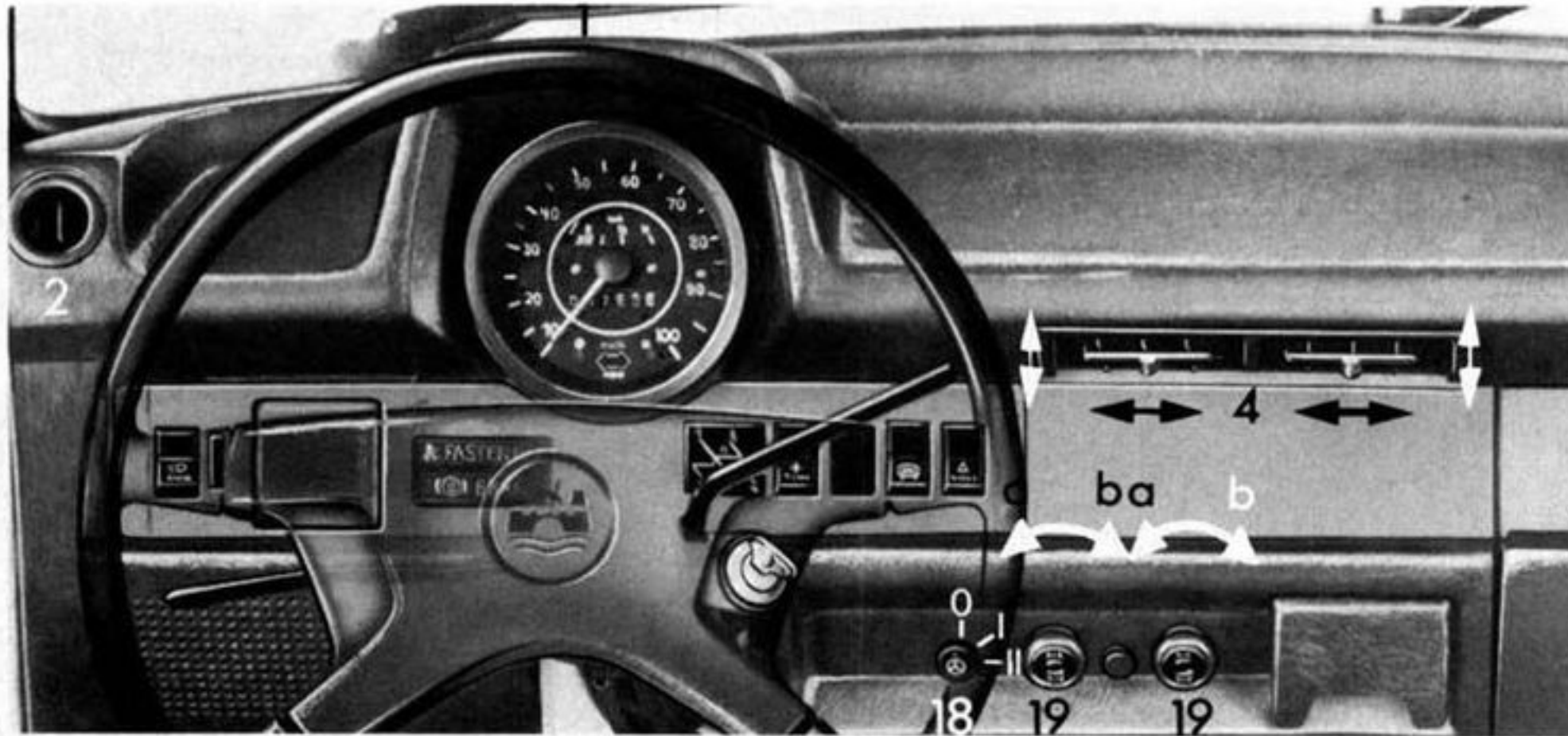

Sliding roof

(optional equipment)

We call the VW with a sliding roof the VW Sunroof.

To open the sliding roof, pull the handle out and turn it counterclockwise; to close the sliding roof, turn the handle clockwise. The sliding roof is locked in any open position.

For safety reasons, fold the handle back into its recess as shown in the illustration.

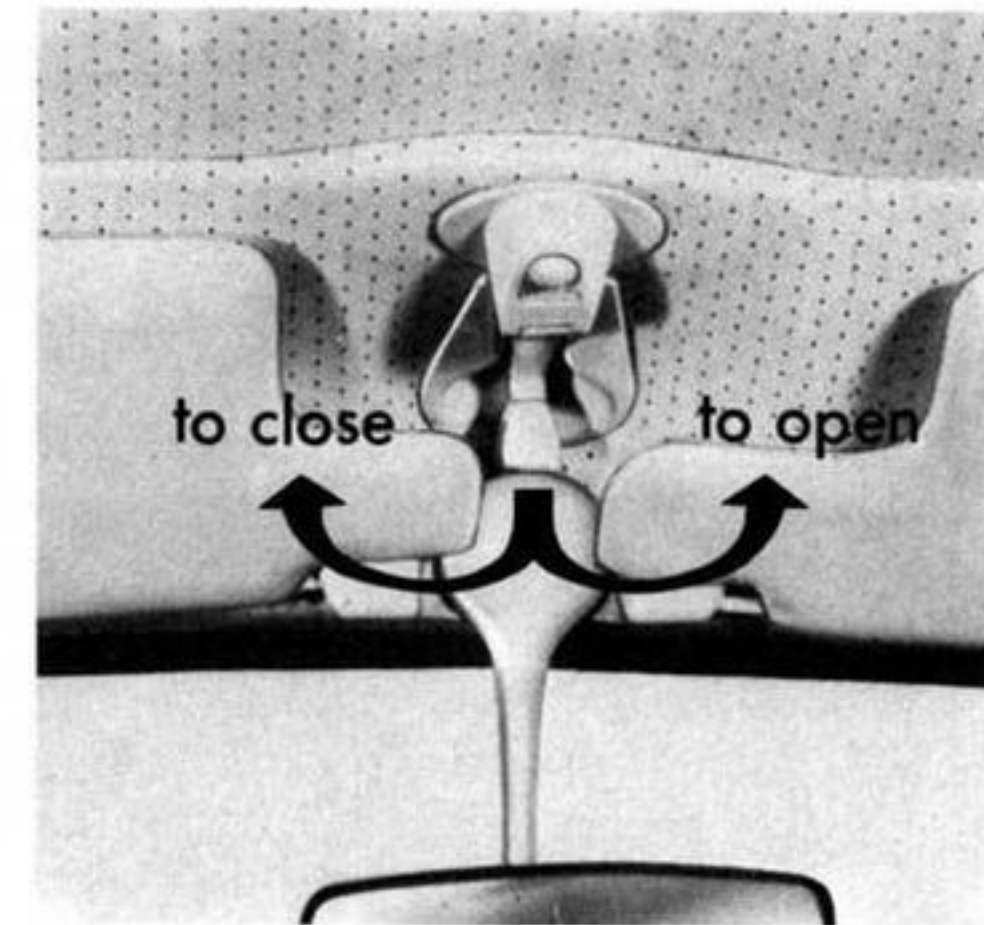

Convertible top

The convertible top should never be opened or closed while the car is in motion.

How to open the convertible top

The top should be dry before you open it.

- 1 – First release the locking levers on the sides above the windshield and fold the top back.
- 2 – Press down the top and engage the locking catches – 1 – on both sides. Make sure the padding does not get caught under the fold-down stop – 2 – or in the linkage.

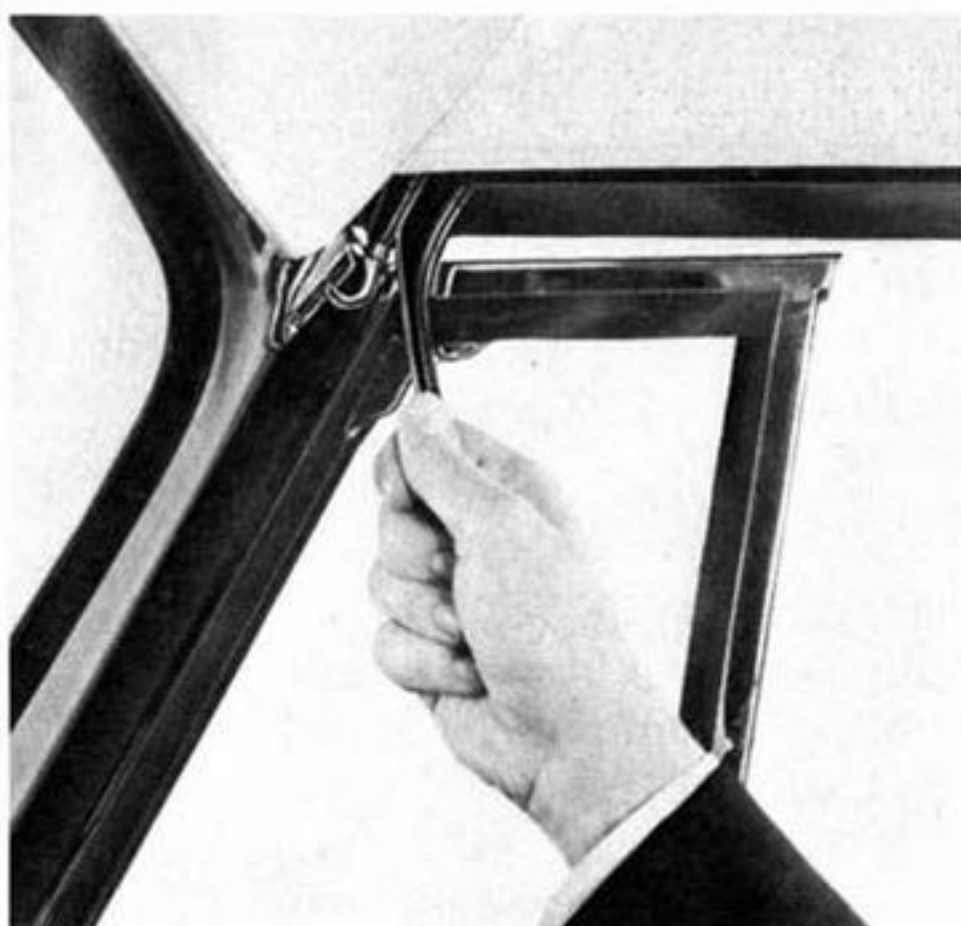

- 3 – Now take the covering boot (a separate cover that comes with every new VW Convertible) and slide it over the folded-down top. Tuck in the sides. Fasten all snaps and rubber straps of the boot securely to the body.

How to close the convertible top

- 1 – The top should be dry before closing it. First take off the boot **and turn down the rear windows**. Press the top down lightly to disengage the locking catches on both sides. Fold the top up and toward the front.

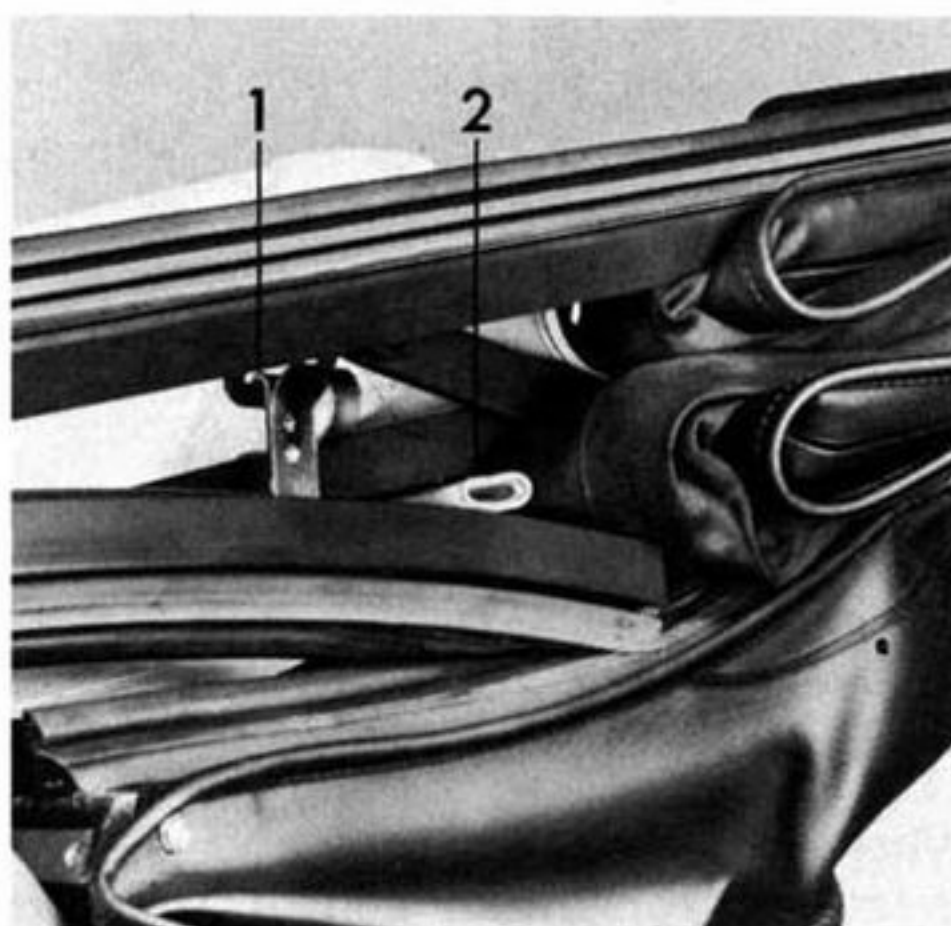

- 2 – From inside the car, grasp both levers and pull the top forward until the pins enter the guide holes on the windshield frame.
- 3 – Engage the hooks at the end of the lever into the grasping brackets above the windshield frame. Now lock the top tightly by pushing the levers upward.
- 4 – As a last step, close the rear windows.



VW Auxiliary Heater (optional equipment)

Do not start or let the engine or heater run in an enclosed, unventilated area to warm up the car. Exhaust fumes from the engine or gasoline heater contain carbon monoxide, which is a colorless and odorless gas. Carbon monoxide may be fatal if inhaled.

Beetle

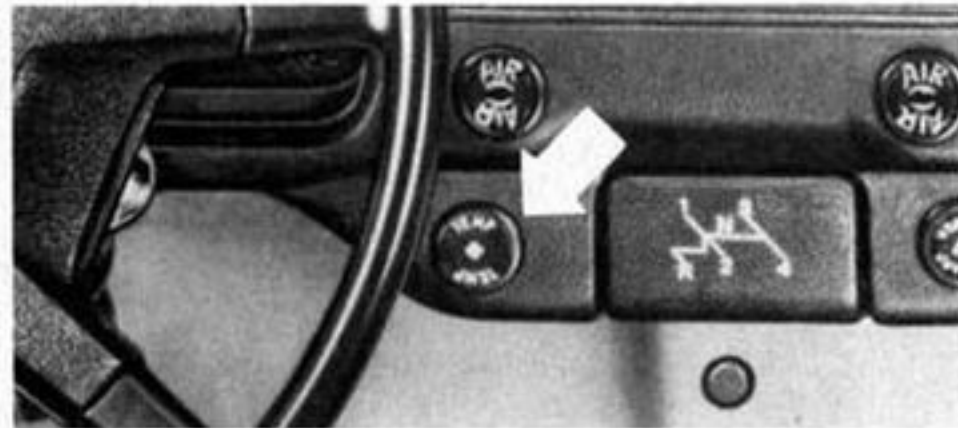

Convertible

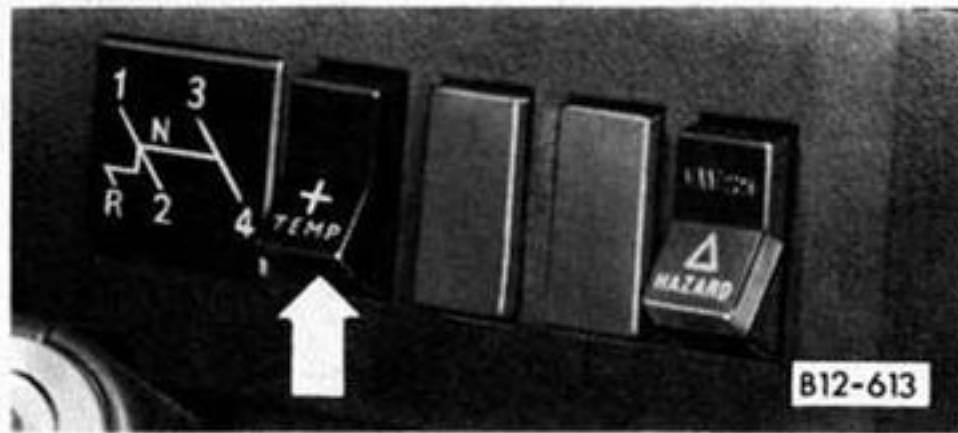

To turn the heater on, pull out the knob (Convertible: depress the lower half of the rocker switch). A green indicator light will light up in the switch.

The indicator light will also glow when the headlight switch is operated while the heater is not in operation. This feature has been provided for easy recognition of the switch in the dark.

To avoid an unnecessary drain on the battery, switch the heater off after about 25–30 minutes if the engine has not been started in the meantime.

A heat limit switch will turn the heater off periodically. The heater will come on again automatically within 3 minutes.

To turn the heater off, push the knob in (Convertible: depress the upper half of the rocker switch). The indicator light then goes out but the blower motor continues to run until the heater has cooled down.

The heater must be turned off when filling the fuel tank.

When it is very cold, full battery capacity is required to start the engine. To avoid

starting difficulties, it is advisable not to preheat the vehicle interior under these conditions.

The heater normally requires no special maintenance. It is advisable, however, to have the heater plug checked once a year before the cold weather sets in and a new plug installed if necessary. The fuel system should also be checked for cleanliness, and the electrical connections for tightness.

During the winter and when driving over very poor roads, mud or snow may tend to accumulate in the exhaust and combustion air intake pipes. Have these pipes checked for blockage from time to time so that the heater continues to work properly.

When the heater is not in use for long periods, for instance during the summer, the fuel in the heater can evaporate. It is therefore advisable to operate the heater briefly once a month when it is not in regular use.

Heat output: 8,000 BTU/h

Fuel: Gasoline from fuel tank

Fuel consumption:

appr. 0.7 U.S. pint/h

(0.6 Imp. pint/h or 0.3 liter/h)

Current consumption: 40 watts

VW Air Conditioner (optional equipment)

Operating controls

Beetle



Convertible



1 – Air volume switch (“FAN”)

This switch serves two functions. It turns the air conditioning system on and off and controls the fan speed.

The sequence of the fan positions is:

OFF – LOW – MEDIUM – HIGH

2 – Air temperature control (“TEMP”)

By progressively turning the control to the right, the desired cooling range can be selected. It is in the coldest position when turned as far as possible to the right.

3 – Air discharge louvers

All louvers can be adjusted up, down or sideways by moving the center vane.

On the **Convertible**, the air flow can be adjusted as follows:

Up and down: by the small tab on the lower edge of the louver housing.

To the sides: by the vanes in the louver housing.

Starting the Air Conditioner

With the windows and fresh air regulator closed, turn the air temperature control to the desired position and select the air volume speed desired. On extremely hot days turn the air volume to full capacity and open a window. Within a few minutes, the hot air will be forced out of the car and the window can be rolled up as cooling starts.

Adjust the air discharge louvers to the desired position.

Stopping the Air Conditioner

Turning the air volume switch to the "OFF" position stops the entire air conditioning system.

When restarting a stalled engine, it is not necessary to turn off the air conditioner. The current to the air conditioner is interrupted during the starting process.

Operational hints

If the car interior becomes too cold after adjusting the air volume, turn the air temperature control to the left until the desired comfort level is reached.

If the windows fog over on the **exterior** on warm, humid days, turn the air temperature control to the left until the windows clear up, or turn the windshield wipers on.

If the windows fog over on the **interior**, they can be quickly cleared by turning on the air conditioner.

During highway driving, set the air temperature control in approximately the middle position.

You can also mix fresh air with air conditioned air by turning on fresh air ventilation (see pages 27 and 28).

Maintenance hints

During the winter season, it is advisable to operate your Air Conditioner for a brief moment every week. This will help to keep the seals and fittings properly lubricated.

After the winter months and before extended summer usage, the air conditioner should be checked and, if necessary, serviced by an Authorized VW Dealer.

The condenser should be checked periodically for cleanliness. If clogged in any area with dirt or insects, the condenser should be washed down with water.

If the condenser fins are bent, the car should be taken to an Authorized VW Dealer for straightening of the condenser fins.

An air-conditioned Volkswagen should only be raised on a lift that provides adequate clearance to prevent damage to the refrigerant hoses.

Circuit breaker

An automatic resetting circuit breaker for the current supply of the air conditioning system is located under the rear seat. It is connected directly to the battery.

Note:

When a VW Air Conditioner is installed, the vehicle capacity weight will be reduced accordingly (see sticker on the inside of the glove compartment door).

Towing and trailer hauling

A – Towing

Always observe local laws and municipal ordinances governing towing.

In an emergency, your VW can be towed as follows:

Beetle

At the **rear**, securely fasten the tow rope around the left or right bumper bracket.

At the **front**, attach the tow rope to the towing eye on the right side of the lower axle tube. This towing eye is for emergency towing over short distances only.

Convertible

Securely fasten the tow rope around the left **or** right bumper bracket at front or rear.

Do not raise the vehicle by these brackets, as this may damage the energy absorbing elements in the brackets.

When towing your VW place the gearshift lever in Neutral. Turn the ignition on to be able to operate parking lights, turn signals and stop lights. Be sure to release the parking brake.

Please keep in mind . . .

The driver of the towing car must be careful when driving off and shifting to avoid sudden and abrupt jerks.

The driver of the towed car must always keep the tow rope taut.

B – Trailer hauling

It is possible to tow a trailer with your Volkswagen.

When towing a trailer, start out in the first gear with this extra load. Also, shift to a lower gear when driving up or down steep hills.

For details about the permissible trailer weights see page 60.

Distribute load in the trailer evenly. And remember: the additional trailer weight affects the braking of your car so that a longer distance is needed to bring the car and trailer to a stop. Test the brakes before starting out on a trip with a trailer.

Winter operation

Battery

During the winter months, more current is consumed when starting at very low temperatures. Lights and the rear window defogger are used more often. Besides, the battery tends to decrease in capacity as the temperature drops.

Therefore, it is very important to keep your battery in the best possible condition. See also "Battery" on page 42.

Do not expose battery to open flame or electric spark as hydrogen gas generated by the battery is explosive. Do not let battery acid come in contact with skin, eyes, fabric or painted surfaces.

A really cold battery may not have the same capacity as a battery at normal temperature. If you mainly drive short distances or in city traffic, have the battery checked and, if necessary, charged between regular inspections.

Door locks

can freeze in the winter if water gets into them. When washing your car in the winter, do not aim the water jet directly at the locks. It is a good idea to put tape over the keyholes to prevent water from seeping in. Water in the locks must be removed with compressed air afterwards. Squirt lock de-icer, anti-freeze, or glycerine into the lock cylinders to prevent the locks from freezing.

To open a frozen lock, warm up the key before inserting it. It might also help to warm the lock. Do not use hot water as it will later freeze in the lock.

Emergency equipment

It is good planning to carry emergency equipment in your car. Some of the things you should have are: window scraper, snow brush, container or bag of sand or salt, flares, small shovel, first-aid kit, etc.

Engine oil

To make starting easier during the cold winter months, we suggest you choose a thinner grade motor oil. Turn to page 55 for the recommended oil grades.

If you drive mostly short distances and in city traffic, we recommend you have your engine oil changed at 1500-mile intervals in the winter.

Transmission oil

SAE 80 W or SAE 80 W/90 (multi-grade) hypoid oil can generally be used in the transmission all year.

See also page 55.

Windshield washer

Add anti-freeze to the washer fluid, such as Volkswagen's Windshield Washer Anti-Freeze & Solvent, to prevent it from freezing. Follow the instructions on the can for the right amount to be used.

Sparks plugs

Make sure the spark plugs are not worn or have a gap larger than 0.028 in. or 0.7 mm.

For further details see page 51.

**Genuine VW Parts:
The people who built
your VW
used them.
And so should you.**



There's nothing but Genuine VW Parts in your new VW.

That's one reason why it runs like a new VW.

No one knows your new VW in quite the same way as the people who built it. And when it comes to replacement parts, we build them to the same standards and specifications as original equipment. So you can be sure of proper VW fit and customary VW performance every time.

As your VW gets on in years, you may find that some genuine VW replacement parts are different from the original parts. That's because when we improve a part for new VWs, there are times when we make the same improvement available for older VWs.

And the only way you can be sure of getting these improvements is with Genuine VW Parts.

One more thing you get with Genuine VW Parts—even after your new car warranty has run out—is warranty protection on every replacement part. Under our Limited Parts Warranty we will repair or replace every defective Genuine VW Part for 6 months or 6,000 miles, whichever comes first.*

And to be sure you're getting Genuine VW Parts, look for this symbol on the package. It stands for VW quality.

Shown on the opposite page are just a few of the genuine VW replacement parts available at our Parts Department. We'll be glad to help you select the right ones for your VW.



*See Parts Department for details.

Autobahn Accessories: They can turn your new VW into your personalized VW.

Autobahn Accessories help personalize your new VW and turn it into an expression of your own individual taste, style and interests.

And because they're Autobahn Accessories, they match your VW exactly. And fit exactly, too.

For music and news, there's a selection of AM/FM and AM/FM stereo radios. Including one that also plays 8-track tapes.

For added dash, add a set of wheel covers or a racy set of stripes. For added visibility, there's a brace of fog lamps. For added protection, add bumper overrides and floor mats. And for the long haul, add a trailer hitch and roof rack.

These are just a few of the many ways you can turn your own VW into your personalized VW. See our Parts Department for assistance in selecting from our complete line of accessories.

Autobahn®

Printed in Germany

Items available at time of purchase may differ from those shown here.



W53-116-7001

Tires

Your Volkswagen is equipped with tubeless bias ply tires which comply with all applicable Federal Motor Vehicle Safety Standards.

Tire pressures

VW-recommended **cold tire inflation pressures** are listed on a sticker on the inside of the glove compartment door.

For good car handling and long tire service life, it is important to maintain recommended tire pressures. Tires which are inflated above or below specifications can cause increased tire wear, increased gas consumption and affect the road holding of the car.

In the interest of safety, check the tire pressure of all tires, including the spare tire, at least once a week, and always before going on a long trip.

For road use do not exceed the maximum tire inflation pressure listed on the tire sidewall.

Spare tire pressure

Since the spare tire supplies the pressure to operate the windshield washer, the pressure of the spare tire should be between 29–42 psi (2.0–3.0 kg/cm²). This pressure level is only to be maintained for the operation of the windshield washer system. For road use, the pressure in the spare tire should be adjusted as specified on the sticker on the inside of the glove compartment door.

Tire rotation

If uneven tire wear should occur, we recommend that the tires be rotated as shown in the sketch below. Afterwards, the tire pressures must be corrected.

The wheel bolts should be torqued diagonally to 94 ft. lbs. or 13 mkg. See also page 40.

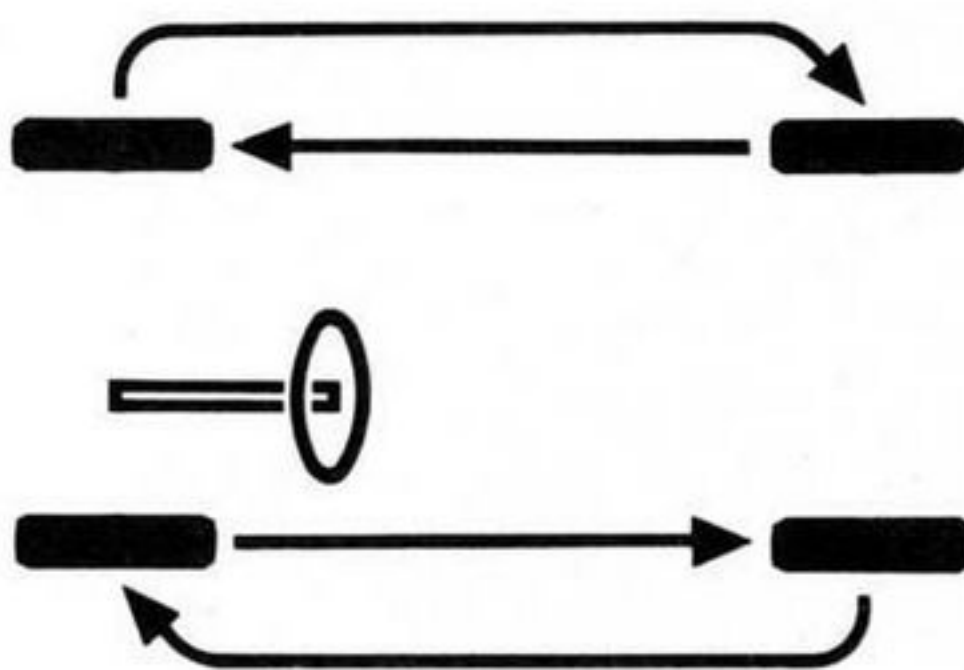

Wheel balancing

A wheel should always be balanced after a tire repair. Also, since regular use can cause tire imbalance, the wheels should be balanced from time to time. Unbalanced wheels may affect car handling and tire life.

Tire wear

The original equipment tires on your VW have built-in tread wear indicators. They are molded into the bottom of the tread grooves and will appear as approximately 1/2 inch bands when the tire tread depth becomes 1/16 of an inch. When the indicators appear in two or more adjacent grooves, it is time to replace the tires. We recommend, however, that you do not let the tires wear down to this extent. Worn tires cannot grip the road surface properly, and are even less effective on wet roads.

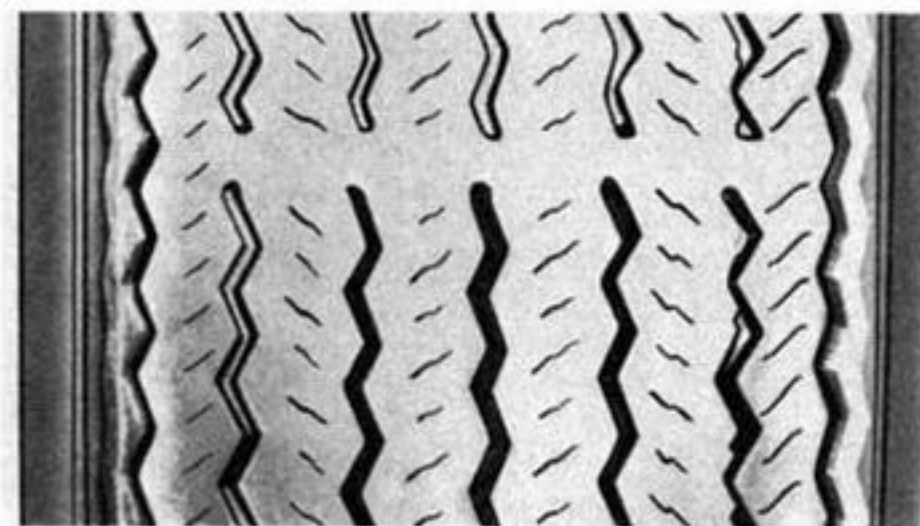

Indicator visible – tread worn

If you notice that tires are wearing unevenly, consult your Authorized VW Dealer. Uneven wear may not always be due to improper wheel alignment. It can be the result of individual driving habits such as cornering at high speeds. If the tire pressure is not checked and adjusted regularly, abnormal tire wear can also occur.

Do not drive with worn tires or tires showing cuts or bruises as they may lead to sudden deflation.

Tire replacement

In the interest of maximum safety and best all-around car handling, always buy replacement tires that show the same specifications with regard to tire size, design, load carrying capacity, tread pattern, etc. This also applies to VW-recommended alternate replacement tires.

Tire specifications are imprinted on the sidewall of the tires. If in doubt, check with your Authorized VW Dealer.

Replace all 4 tires at the same time. If this is not possible, replace tires in pairs, either front or rear.

New tires do not possess maximum traction. They tend to be slippery. Break new tires in by driving at moderate speed for the first 60–100 miles.

Winter tires

Winter tires give good traction in snow or slush.

For more traction on snow or ice, you can use winter tires with studs, but **check with your local Motor Vehicle Bureau for possible restrictions.** Winter tires with studs should be run at moderate speed when new to give the studs time to settle.

Winter tires should preferably be mounted on all four wheels. They should also conform to the same load requirements as original equipment tires.

Inflation pressures for winter tires are listed on the sticker on the inside of the glove compartment door. **Do not exceed the maximum tire inflation pressure listed on the tire sidewall.**

Winter tires do not fulfill their purpose if the tread depth is less than $\frac{5}{32}$ " (4 mm). For safety reasons, it is not advisable to drive with winter tires at top speeds. Winter tires do not have the same degree of traction on dry, wet or snow-free roads as regular tires.

The driving direction should be clearly marked on all tires before removing them for storage. This is to make sure that they are mounted and run in the same direction as before.

Tire care

- 1 – Frequently check tires for damage. Remove imbedded material.
- 2 – Keep oil and gasoline away from tires.
- 3 – Replace worn tires in time.
- 4 – Replace missing valve dust caps as soon as possible.

Spare wheel

The spare wheel is connected to the windshield washer container and supplies the pressure to operate the washer. The air supply to the windshield washer will be interrupted automatically by a cut-off valve if the tire pressure drops to 26 psi (1.8 kg/cm²). This prevents the spare tire from being deflated below the required pressure.

Check the tire pressure from time to time and maintain it up to a maximum of 42 psi (3.0 kg/cm²). This pressure level is only required for the operation of the windshield washer system. For road use, adjust the spare tire pressure as specified on the sticker on the inside of the glove compartment door.

The spare wheel is under the front hood. To unlock the hood, pull the lever inside the glove compartment.

The spare wheel is stored in an upright position in the spare wheel well.

Checking or correcting the tire pressure

Disconnect the windshield washer hose from the valve of the spare tire. Reconnect the hose after inflating or checking.

Beetle

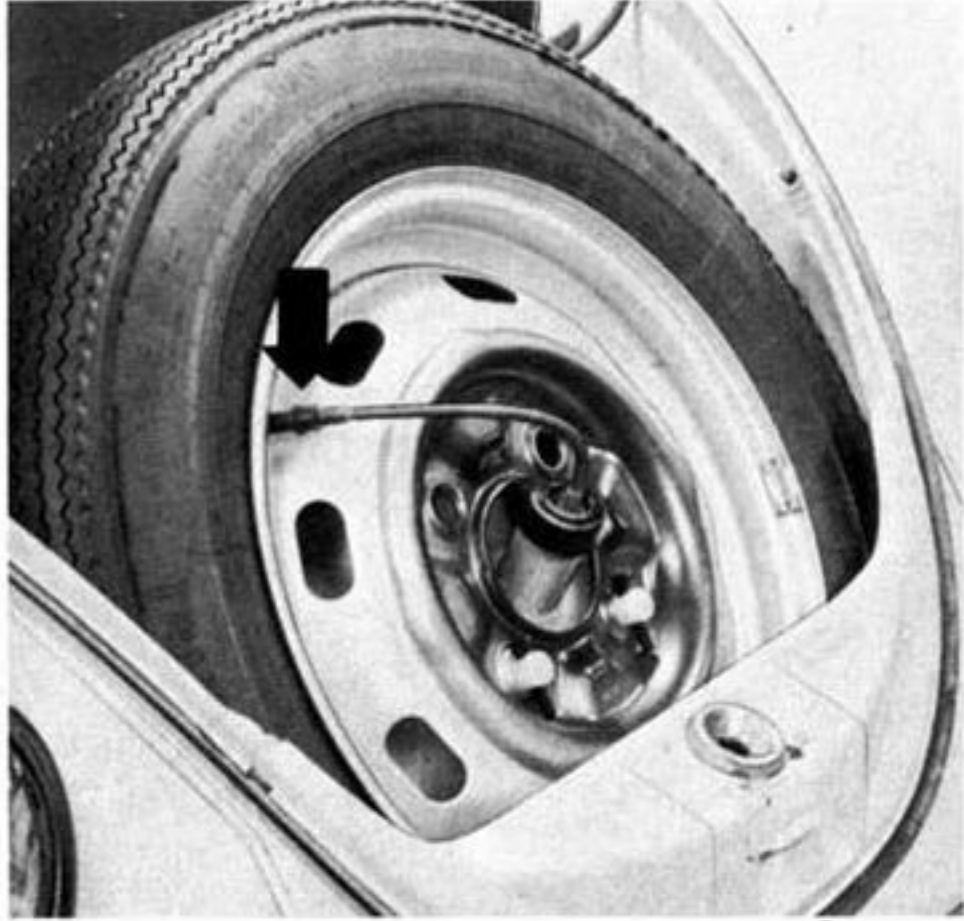

On the Convertible, the spare wheel is stored horizontally under the luggage compartment cover.

First unscrew the hose from the valve near the filler cap of the windshield washer container. The spare wheel is connected to this valve and can therefore be pressurized via this valve. Reconnect the hose to the valve after checking or inflating the spare tire.

Convertible

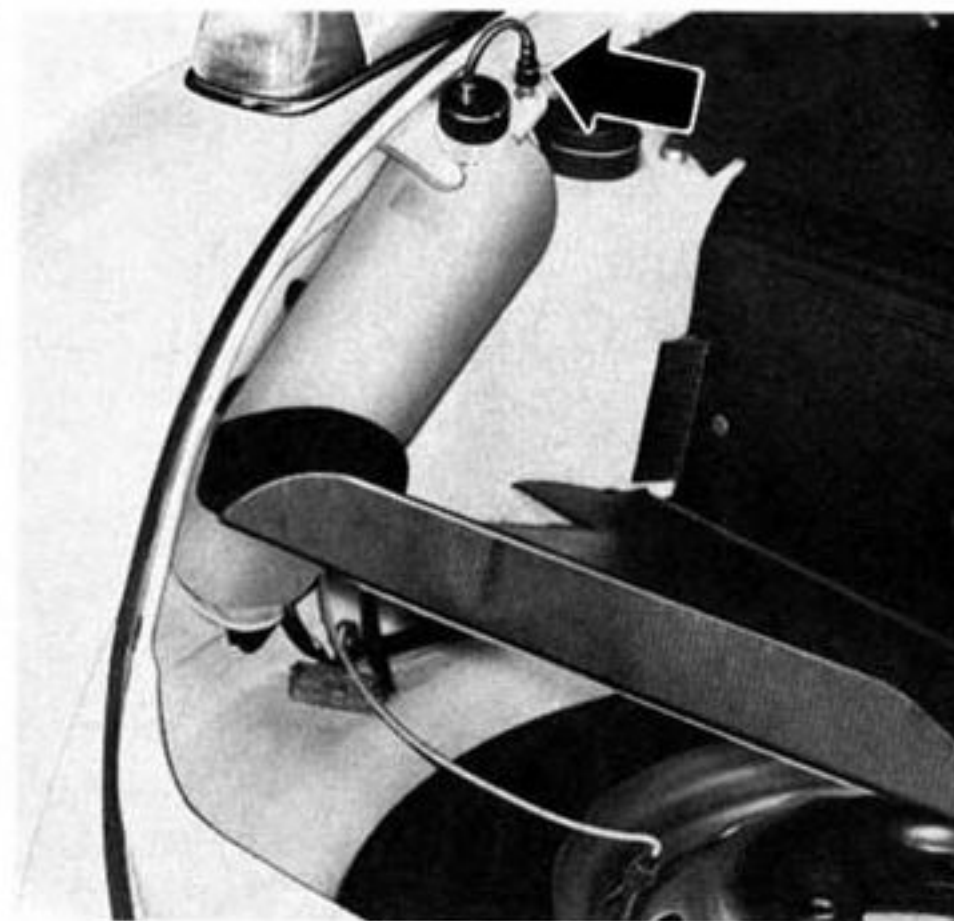

Jack

The jack is only to be used for changing a wheel. Do not use it as a support to work underneath the car.

The jack is located under the rear seat next to the battery. It is held in stowage position by a clamp. To take out the jack, take out the rear seat (see page 47) and lift the clamp. Before putting the jack back in again, wind it down sufficiently. Tighten the clamp.



Changing a wheel

If you have a flat tire, **move off the road. Turn on the emergency flasher. In addition, mark the position of your car with flares or other warning devices to alert other motorists.**

Before you change a wheel, be sure **the ground is level and firm, especially near the rear wheels where the jack ports are.**

Set the parking brake and block the wheels opposite the defective wheel on the other side of the car.

For a more efficient and safe changing of a flat tire, observe the following 10 steps.

Further on, we expand on these steps in greater detail.

Step 1 – Take out tools, jack and spare wheel.

Step 2 – Remove hub cap.

Step 3 – Loosen wheel bolts. **Do not take them out.**

Step 4 – Securely insert the jack in jack port. There is **one** for each side. It is under the running board toward the rear, and is used for front or rear wheel changing.

Never jack the car up by the bumper or the running board.

Step 5 – Jack up car.

Step 6 – Change wheel and handtighten wheel bolts.

Step 7 – Lower car.

Step 1

Take out the **jack** from under the rear seat next to the battery (see previous page).

Take out **tool kit and spare wheel** from front luggage compartment.

Before you take out the **spare wheel**, disconnect the hose leading to the windshield washer container (see large arrow on picture 1 a and picture 1 b).

Beetle

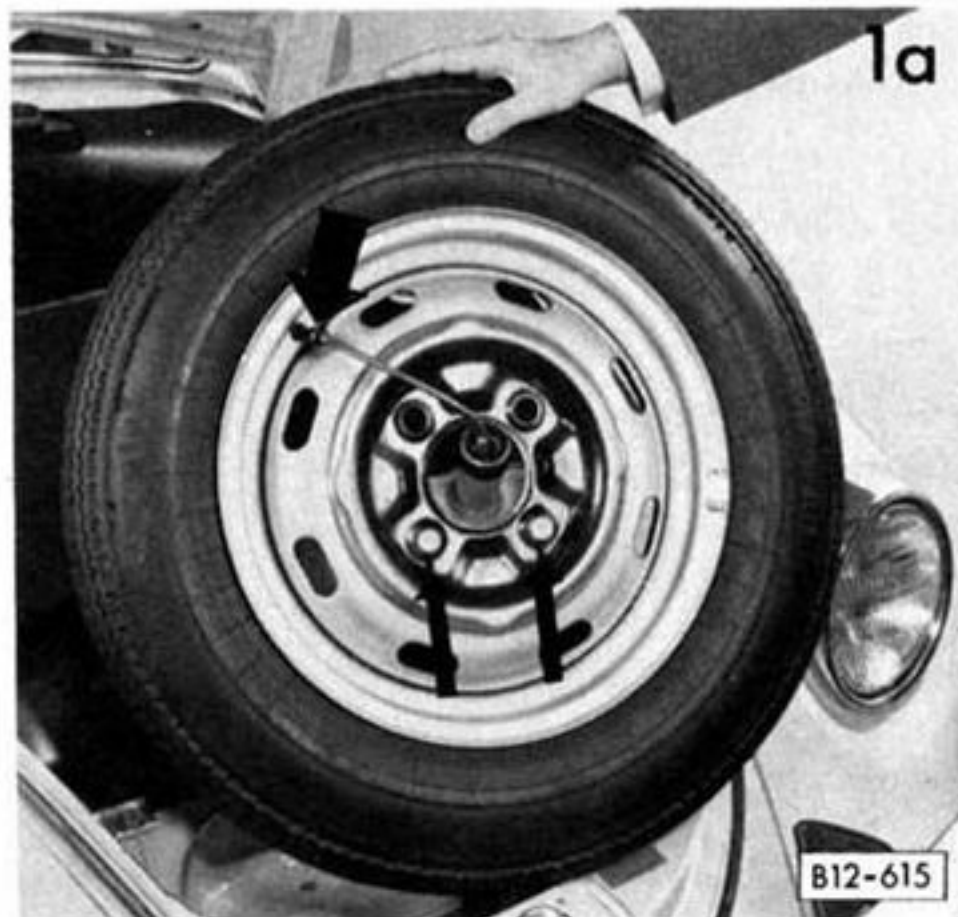

Step 8 – Further tighten the wheel bolts.

Step 9 – Reinstall hub cap.

Step 10 – Torque and air pressure adjustment.

In the **VW Beetle**, lift the **spare wheel** up and place it on the edge of bumper. This way you have better access to the two wedges (small arrows in picture 1 a) that hold the washer container in the rim. Remove the wedges and separate the container from the wheel. **Convertible**

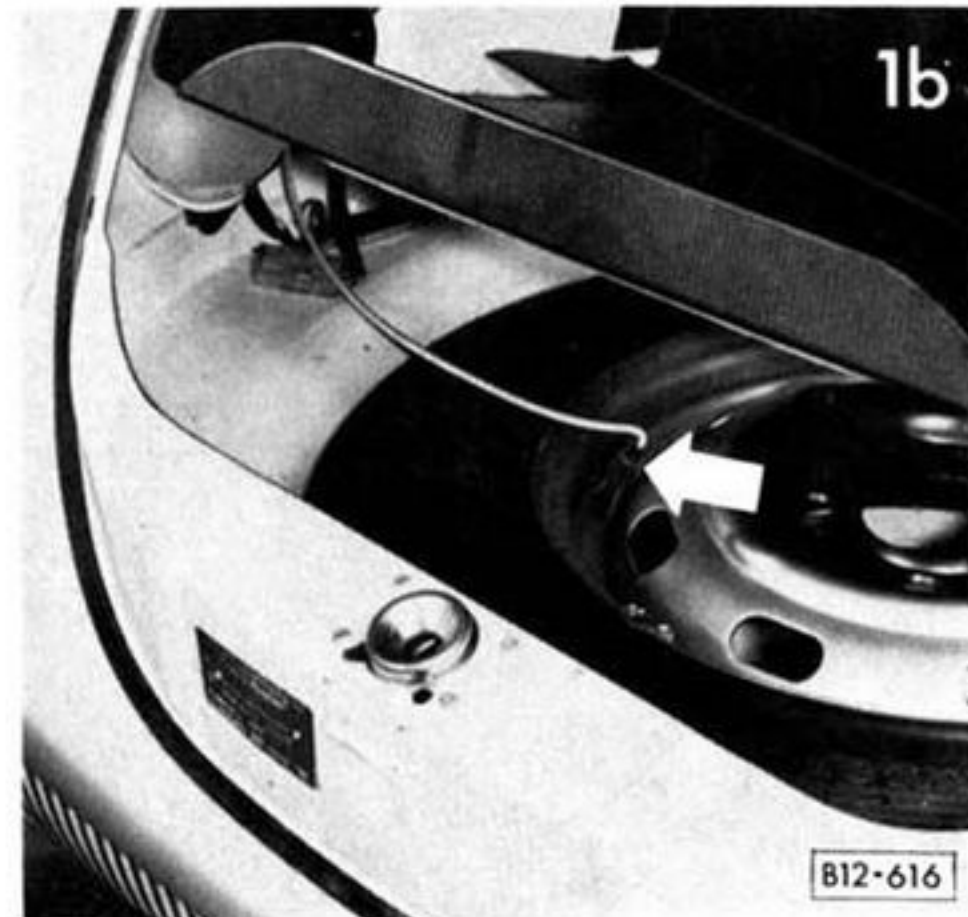

Step 2

With the wheels still firmly resting on the ground, remove the hub cap of the defective wheel.

Insert the puller in the holes at the rim of the hub cap. Put the breaker bar through the puller, brace one end of the bar on the wheel rim and tug lightly on the other end.

When you place the hub cap face down, you can use it as a tray for your wheel bolts.

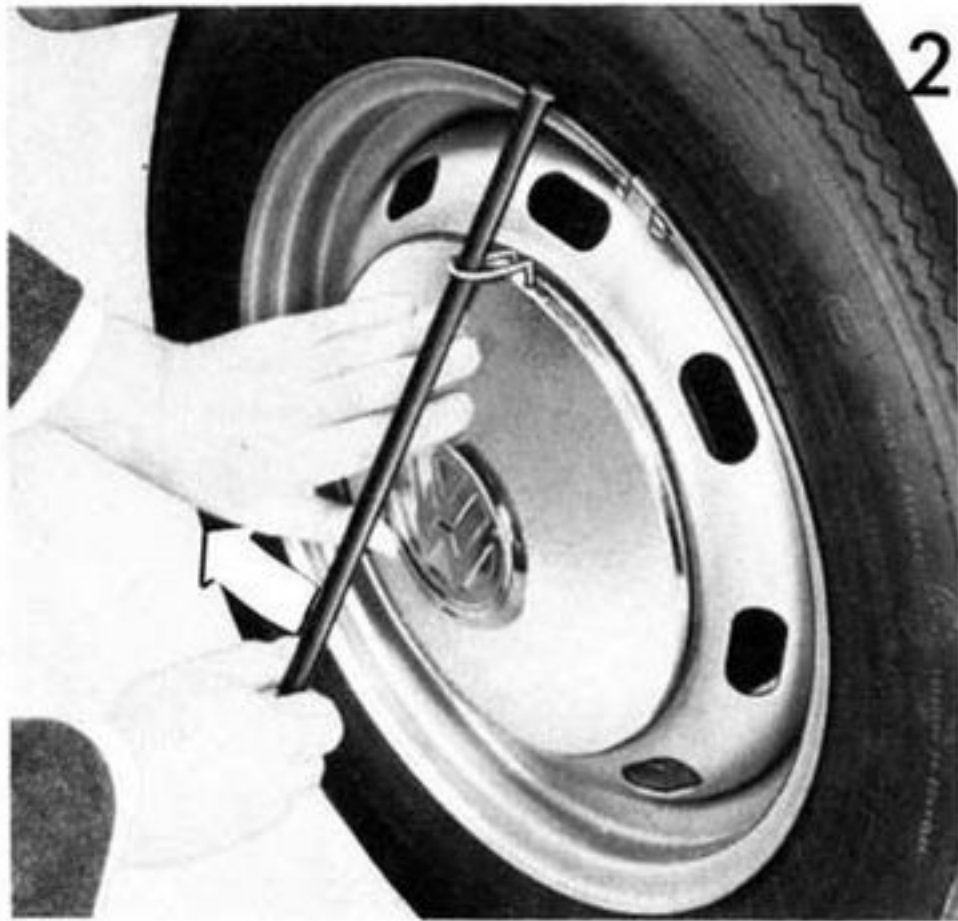

Step 3

Loosen all wheel bolts counterclockwise about one turn with the socket wrench. Insert the breaker bar to make full use of its leverage. **Do not yet remove the bolts.**

3 = to loosen



8 = to tighten



Step 4

Securely insert the jack into the jack port. There is one on each side under the running board toward the rear and is used for front and rear wheel changing. **Never jack the car up by the bumper or running board.**

Provide for a **firm base for the jack on the ground.** If necessary, use a board.

Passengers should not remain in the car when the car is jacked up.

a = to raise

b = to lower

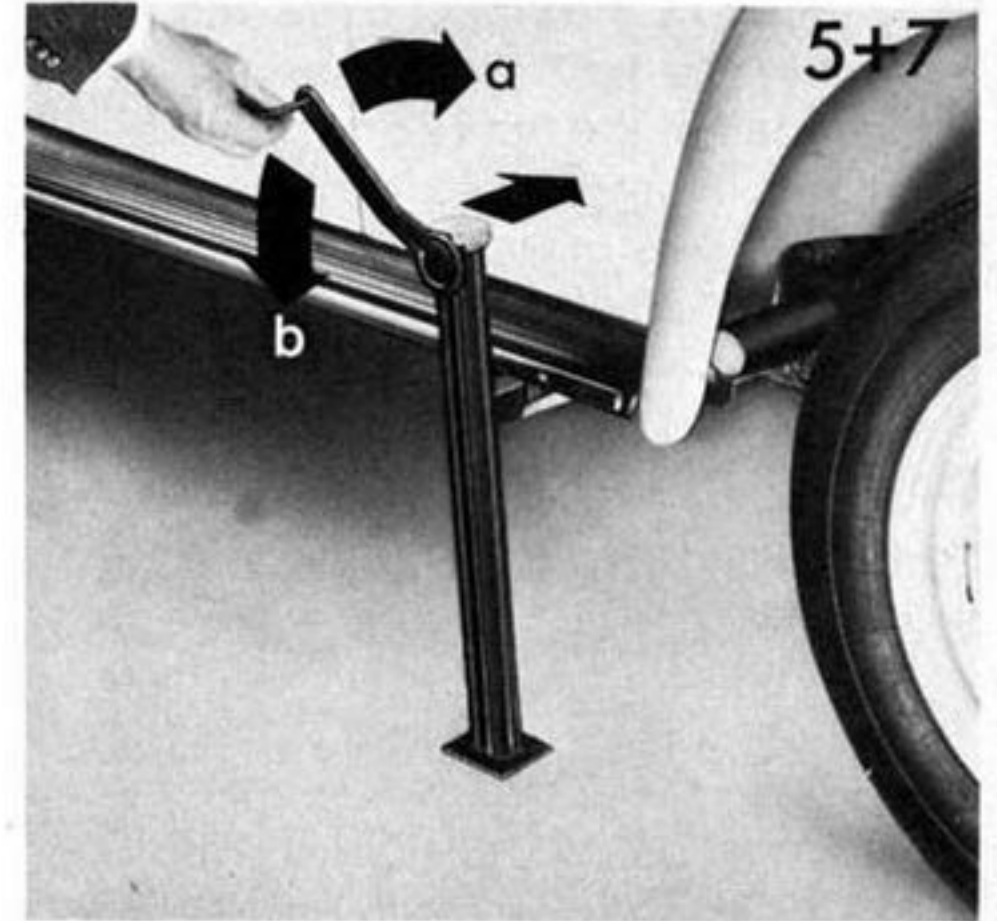

Step 5

Do not raise the car until you are sure the jack is securely engaged.

To raise the car, turn the handle clockwise.

To get the jack as vertical as possible, push the upper part of the jack toward the body while you are jacking up the car.

Only raise the car as much as is needed to change a wheel.

Step 6

Fully unscrew the wheel bolts and place them into the hub cap. Place the spare wheel against the brake drum so that the bolt holes in the wheel are in line with the threaded holes in the brake drum. Insert the wheel bolts and handtighten them crosswise before jacking the car down.

Step 7

To lower the car, turn the handle counterclockwise.

Step 8

Then go crosswise from one bolt to another, tightening them firmly with the socket wrench and breaker bar.

Step 9

To install the hub cap, place it around the lower part of the wheel center, and with a firm push on the upper part, the hub cap will snap into place. Make sure it is properly seated.



Step 10

Correct tightness of the wheel bolts is important.

Correctly tightened bolts should have a torque of 94 ft. lbs. or 13 mkg. This torque can be obtained with socket wrench and breaker bar by any person of average strength. If in doubt about the correct tightness of the wheel bolts, have it checked with a torque wrench by your dealer or a service station.

Also, correct the **pressure of the tire** you have just put on.

Recommended tire pressures are listed on a sticker on the inside of the glove compartment door.

Container for windshield washer fluid (1)

The capacity of the windshield washer container is listed on page 61.

To add washer fluid, just unscrew the filler cap. The container can be filled to the top.

As clear water is usually not adequate for cleaning the windshield, add a cleaning solution to the water such as Volkswagen's Windshield Washer Anti-Freeze & Solvent. It is a concentrate, so follow the directions on the can for the correct amount to be used.

You can use Volkswagen's Windshield Washer Anti-Freeze & Solvent all year.

It helps to keep your windshield clean, and prevents freezing of the washer fluid in the winter.

Since the spare tire supplies the pressure to operate the washer, it should always be kept up to a pressure of 42 psi (3.0 kg/cm²). To pressurize the spare tire, see page 36.

Beetle



Convertible



Brake fluid reservoir (2)

The brake fluid should always be above the seam edge near the top of the reservoir. If it drops below this point, the cause should be corrected by your Authorized Volkswagen Dealer.

Every 2 years, the brake fluid has to be replaced.

See also Warranty and Maintenance booklet.

Only **new, unused** brake fluid that meets the SAE recommendation J 1703 and conforms to Motor Vehicle Safety Standard 116 must be used.

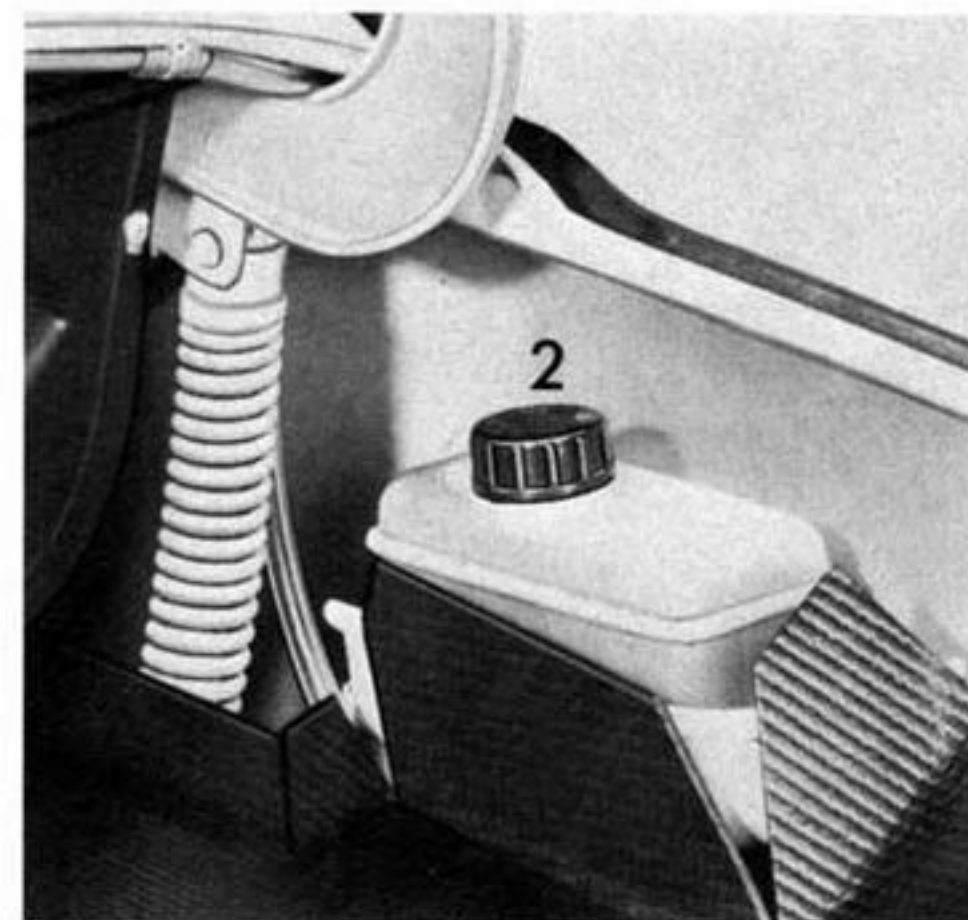

Battery

The electrical system depends mainly on the battery. Therefore, the battery should be checked regularly and kept in good working condition.

The battery is under the rear seat on the right, as seen in driving direction. Just take the rear seat out (see page 47).

Never drive the car with a disconnected battery as this may damage the electrical system.

Do not expose the battery to an open flame or electric spark. Hydrogen gas generated by the battery is explosive. Do not let battery acid come in contact with skin, eyes, fabric, or painted surfaces.

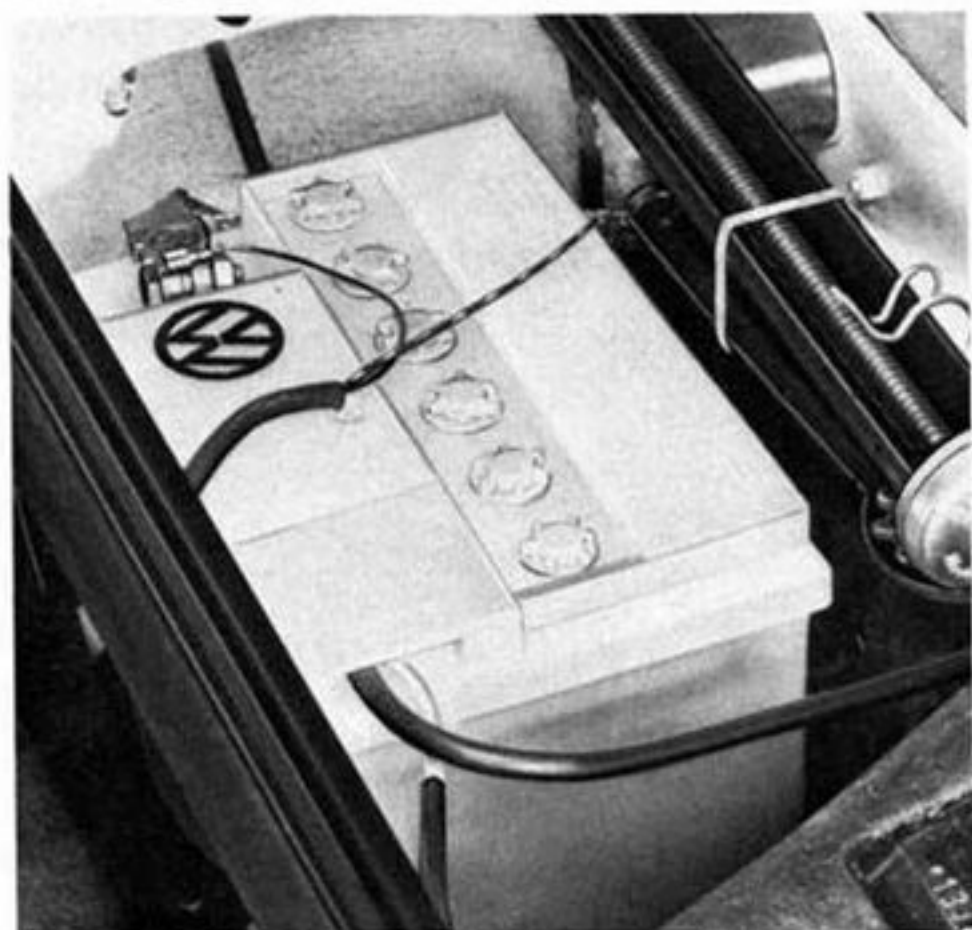

42

Each filler plug has to be unscrewed to check the fluid level in each cell. If it is **below** the indicator, top it up with distilled water. **Only fill up to indicator**, otherwise the electrolyte will overflow when the battery is being charged and cause damage.

How often water must be added to the battery depends mainly on operating conditions and on the time of year. As a general rule, the battery electrolyte level must be checked more often in the summer than in the winter, and more often when driving long distances.

The terminals and connections should be kept clean and greased with silicone spray or petroleum jelly. Make sure the ground connection to the body is tight and free of corrosion.

When working on the battery, be sure not to short circuit the terminals. This would cause the battery to heat up very quickly, which could lead to damage.

Before having a quick-charge performed on a battery installed in a car, **disconnect both terminals to avoid serious damage to the electronic components of the electrical equipment.**

If you have not used your car for an extended period of time, have the battery recharged.

Fuel supply

VW with catalytic converter:

Unleaded fuels only.

Note

Do not use fuel additives containing sulfur, zinc, nickel or barium as they adversely affect the catalytic converter.

All other VWs: "Regular", incl. low-lead and unleaded fuels.

The minimum octane rating is shown on the label on the inside of the fuel tank flap. If regular fuels with adequate anti-knock qualities are not available, premium fuels should be used or mixed with regular fuel. This might be necessary when traveling outside the United States or Canada if regular gasolines have a lower octane rating than recommended by the manufacturer.

The Auxiliary Heater (optional equipment) must be turned off when filling the fuel tank.

Never start or let the engine run in an enclosed unventilated area. Exhaust fumes from the engine contain carbon monoxide which is a colorless and odorless gas. Carbon monoxide can be fatal if inhaled.

The filler neck to the fuel tank is behind a flap on the side panel above the right front fender. A finger moulding makes opening and closing the flap easier.

The capacity of the fuel tank is listed on page 61.

When putting the cap back on, turn the threaded filler cap until you hear a click.

Catalytic converters (where applicable)

Cars equipped with catalytic converters for the emission control system require unleaded fuels for the engine. Deposits from leaded gasolines and fuel additives containing sulfur, zinc, nickel or barium render catalytic converters inoperative, and thus defeat their purpose to control harmful exhaust emissions.

Cars with catalytic converters are so identified by a sticker on the dashboard and another sticker next to the fuel filler flap.

Unleaded fuel

Cars with catalytic converters requiring unleaded fuel will have smaller fuel tank openings, and gas station pumps will have smaller nozzles. This will prevent accidental pumping of leaded fuel into cars with catalytic converters.

Unleaded fuels may not commonly be available outside the United States. Therefore Volkswagen of America, Inc. or Volkswagenwerk AG does not recommend the sale of VW cars for use in areas in which unleaded fuels are not available.

Fuses

A failure in the electrical system may cause a burned fuse.

Before replacing a fuse, the ground terminal on the battery should be disconnected. If this is impossible, all electrical components including the ignition have to be turned off.

The 12-point fuse box is located under the instrument panel.

Take cover off.

To replace a fuse, simply depress a contact on either side of the fuse.

Carefully install new fuse with metal strip facing you. The fuse must fit tightly between the contact springs – do not bend the springs.

Reinstall cover.

When a fuse is blown, it is not sufficient to merely replace it. The cause of the short circuit or overload must be found. On no account should fuses be patched up with tin foil or wire as this may cause serious damage elsewhere in the electrical circuit.

It is advisable to always carry a few spare fuses in the car.

Fuse arrangement

according to the numbers on the fuse box cover:

- 1 – Tail light left
- 2 – Tail light right, parking and side marker lights, license plate light.
- 3 – Low beam left
- 4 – Low beam right
- 5 – High beam left, high beam warning light.
- 6 – High beam right
- 7 – (free for subsequent installation of electrical equipment)
- 8 – Emergency flasher
- 9 – Interior light.
- 10 – Windshield wipers, fresh air fan, rear window defogger (switch current)
- 11 – Safety belt warning system incl. warning light, stop lights, brake warning light, horn
- 12 – Turn signals, fuel gauge, warning lights for alternator, engine oil pressure, turn signals and EGR (exhaust gas recirculation)

Fuse No. 9 and 10 = 16 amps. (red colour)
all other fuses = 8 amps. (white colour) 43

Additional fuses

Electrical equipment	Fuse	Location of fuse holder
Back-up lights	8 amp.	In the engine compartment above the ignition coil (A)
Rear window defogger (main current)	8 amp.	Underneath the rear seat on the left (B), (as seen in driving direction).
Auxiliary heater (optional equipment)	16 amp.	In the front luggage compartment near the heater (C)

To replace a fuse in an inline fuse holder, pull the holder out of the clip, where necessary. To open the holder, grasp both ends of the holder, press lightly together and twist counterclockwise. Install fuse. To close the holder, put both ends together again, press lightly and twist clockwise.

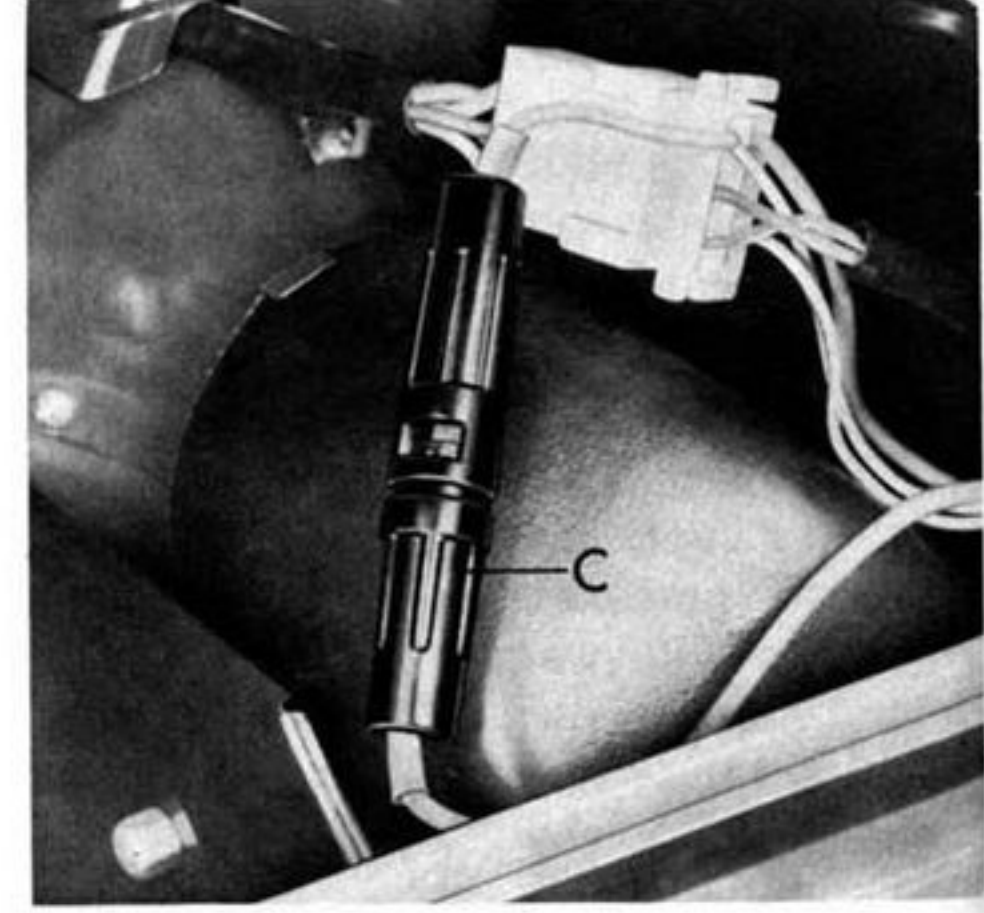
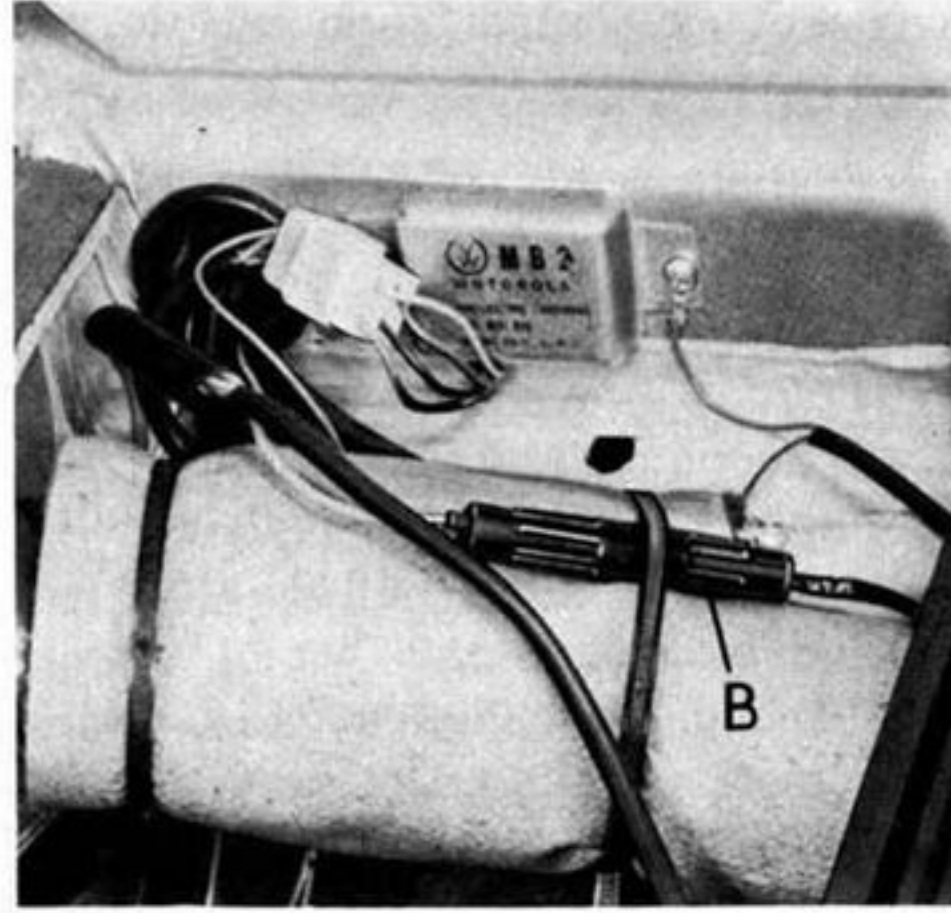
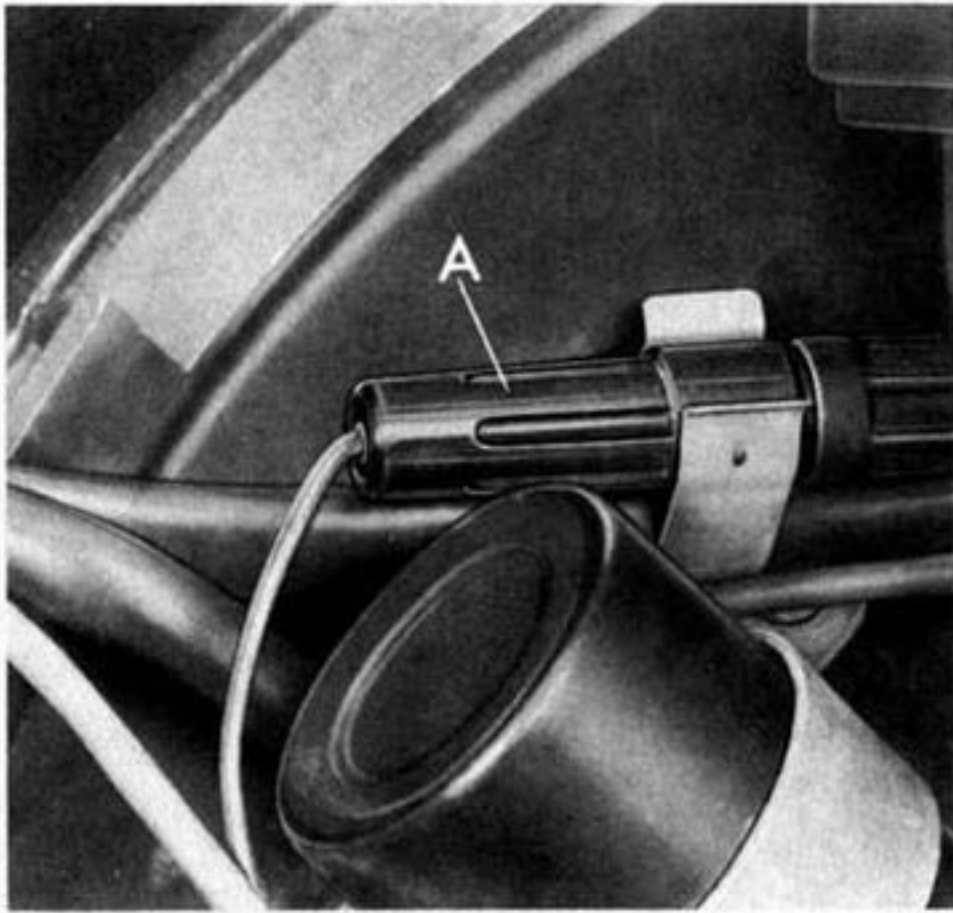

Cleaning your VW

The paint on your VW is very durable, and so is the upholstery. But a car can get a lot of abuse from industrial fumes and corrosive road salt to half-eaten lollipops and muddy dog feet.

A well-cared-for VW can look like new 10 years later. It all depends on the owner and the amount of care he is willing to give to his car.

Here are a few hints on how to keep your VW looking young and beautiful. We have also compiled a list of cleaning products. They are available at any VW Dealer.

Whenever using VW-recommended products or other cleaning agents, **follow the directions on the containers. Be aware of warning or caution labels.**

Washing your VW

The longer the dirt is left on the paint, the greater the risk of damaging the glossy finish, either by scratching if the dirt is rubbed into the paint, or simply by the chemical effect dirt particles have on the paint surface.

Therefore dirt should be washed off as soon as possible. NEVER WASH IN DIRECT SUNLIGHT.

Use plenty of water, a car-wash soap, such as VW's Car Wash and Wax, and a

Application	Volkswagen Product
Car wash and liquid wax	Car Wash and Wax
Paint waxing	Classic Car Wax
Paint polishing and paint waxing, remove paint oxidation	One-step Wax Polish
Preservation of chrome parts	Chrome Preservative
Paint touch-up	Touch-Up Paint (all colors)
Convertible top cleaning, Upholstery cleaning, Whitewall tire cleaning	All Purpose Cleaner
Windshield cleaning and washer anti-freeze	Windshield Washer Anti-Freeze & Solvent

soft sponge or hose brush. Begin by spraying water over the dry car to remove all loose dirt before applying the lukewarm soap/water solution.

Use plenty of water to rinse the car off. Wipe the car dry with a chamois to avoid water spots.

Waxing

Waxing is not really needed when you have washed your car with VW's Car Wash and Wax. If you do not use a car wash liquid with wax, apply wax to preserve the natural shine of the car.

To obtain a long lasting wax finish apply hard wax, such as VW's Classic Car Wax,

eight to ten weeks after buying the car. Wax again when water remains on the surface in large patches instead of forming beads and rolling off.

Polishing

Use a polish later in the car's life when the paint appears dull and loses its shine. **Do not polish the new car.**

Always apply wax after polishing if the polish you are using does not contain a wax. VW's One-step Wax Polish polishes your car, removes paint oxidation and also waxes your car.

Cleaning windows

Clean windows with a sponge and warm water. Dry with a chamois.

Weatherstrips

To seal properly, weatherstrips around windows and doors must be pliable. To retain flexibility of the rubber, spray with silicone, available from your VW Dealer, or coat with talcum powder.

Windshield wiper blades

Remove the wiper blades periodically and scrub with a hard bristle brush and alcohol or a strong detergent solution.

Chrome care

To protect the car's chrome, apply chrome preservative.

Touch-up paint

Your dealer has touch-up paint for minor scratches and stone chips. Scratches should be touched up soon after they occur.

Care of chassis

The underside of the car picks up dirt and salt and should be sprayed with a powerful jet of water. This is easier to do after the car has been driven in rain.

Removing spots

46 **Do not use gasoline, kerosene, naphtha,**

nail polish remover or other volatile cleaning fluids. They may be toxic or flammable or hazardous in other ways. Only use spot removing fluids in well ventilated areas. Keep them out of reach of children.

Tar

Do not allow tar to remain on the paint finish. Remove it as soon as possible with a cloth soaked with a special paint cleaner. If you do not have a spot remover, you may substitute with turpentine. After applying a cleaning fluid, always wash with a lukewarm soap/water solution and apply a new wax coat.

Insects

Remove as soon as possible with a lukewarm soap/water solution or apply insect remover.

Tree sap

Remove with a lukewarm soap/water solution. Do not allow tree sap to harden on the paint surface.

Cloth upholstery and carpet

Clean with a vacuum cleaner or a hard bristle brush. Dirt spots can usually be removed with a lukewarm soap/water solution.

Use spot remover for grease and oil spots. Do not pour the liquid on the cloth material. Dampen a clean cloth

and rub carefully, starting at the edge and working inward.

Leatherette and interior trim

Use VW's All Purpose Cleaner or a dry foam cleaner.

Grease or paint spots can be removed by wiping with a cloth soaked with VW's All Purpose Cleaner. Leatherette parts of the headliner and side trim panels can be cleaned with a soft cloth or brush and All Purpose Cleaner.

Cleaning the convertible top

The top does not require any special care. Wash off dirt as soon as possible. **Do not wash in direct sunlight.** Use lukewarm water together with VW's All Purpose Cleaner. A hard bristle brush will help to loosen dirt from the grained surface of the material. Avoid scratching the body of the car with the bristles.

To remove spots, use a stronger solution of VW's All Purpose Cleaner. Never use paint thinner, nail polish remover or similar agents as they may have adverse effects on the top material.

After cleaning and washing the top, rinse the car well with clear water.

Clean the **pivot points of the top linkage** from time to time, and lubricate them lightly with a few drops of oil. Wipe off excessive oil to prevent oil from dripping on the top material.

Removing and installing rear seat

Do this through the passenger's door. Raise the front edge of the seat and pull it slightly toward you. Reposition the safety belts. For easier removal, tilt the right side of the rear seat up (as seen in driving direction).

When doing this, be careful not to damage the backrest with the retaining hook on the rear edge of the seat cushion. Position the seat diagonally and take it out through the right door.

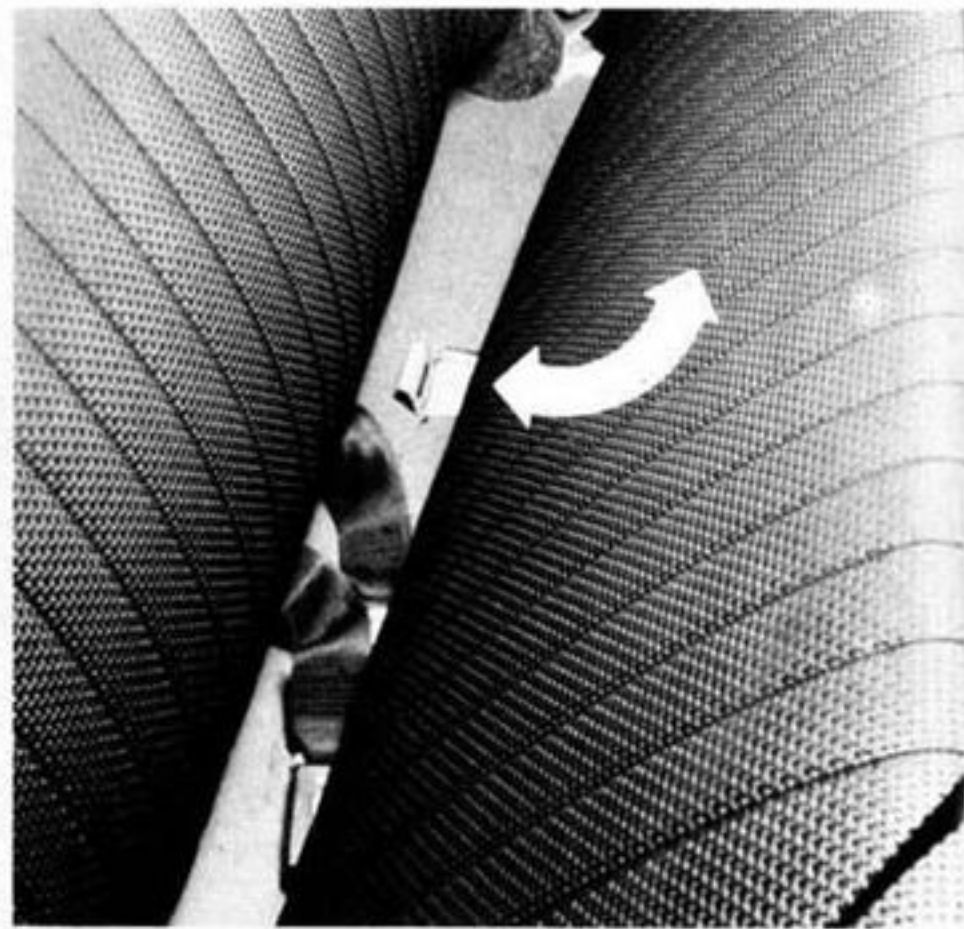

When putting the seat back in again, follow the same steps in reverse order. Lift the seat into the car through the passenger's door, holding the seat diagonally with the right end of the rear seat tilted up. With the front end of the seat tilted up, slide the seat fully back under the backrest to engage the retaining hook. **Position the safety belts on top of the seat cushion.** Press down the front edge of the seat to firmly position it in place.

Do not drive with the rear seat cushion removed and the backrest folded down. In the folded down position, the backrest may interfere with the operation of the front safety belts.

Bulb chart

Bulb for	Trade bulbs	VW Part No.
Sealed beam (headlights)	6014	ZVP 118 114
Front turn signal/parking lights	1034	ZVP 118 034
Side marker lights	1816	ZAP 118 816
Rear turn signal	1073	ZVP 118 073
Stop lights	1073	ZVP 118 073
Tail lights	67	ZVP 118 067
Back-up lights	1073	ZVP 118 073
License plate light	89	ZVP 118 089
Warning, indicator and instrument lights in speedometer (and clock)	—	N 17 722 2
Warning and indicator lights for brake operation, emergency flasher and Auxiliary Heater	—	N 17 751 2
Indicator light for rear window defogger: Beetle	—	N 17 722 2
Convertible	—	N 17 751 2
Spot light for heater levers	—	N 17 751 2
Interior light: Beetle	211	ZVP 118 211
Convertible	—	N 17 725 2

Replacing bulbs

Headlights

Your Volkswagen is equipped with double filament seven inch sealed beam units. Should it become necessary to replace a unit, loosen screw in the center of the trim ring below the headlight and take off the trim ring:

Firmly grasp the loose screw – a – (non-removable) and pull trim ring off.

Remove three short screws – b – in sealed beam retaining ring and take ring off.

Do not alter the position of the long headlight adjustment screws (– c –).

Take sealed beam unit out of support ring and pull cable connector off.

When installing new sealed beam units, be sure the three glass lugs engage properly in the support ring.

Loosely insert the screw for the trim ring and turn for 2 or 3 turns.

Position edge of trim ring over upper lug. Press ring over lug and tighten screw.

If no other headlight part as described here was removed or its position changed, it should not be necessary to aim the headlights. If in doubt have the adjustment checked at your dealer.

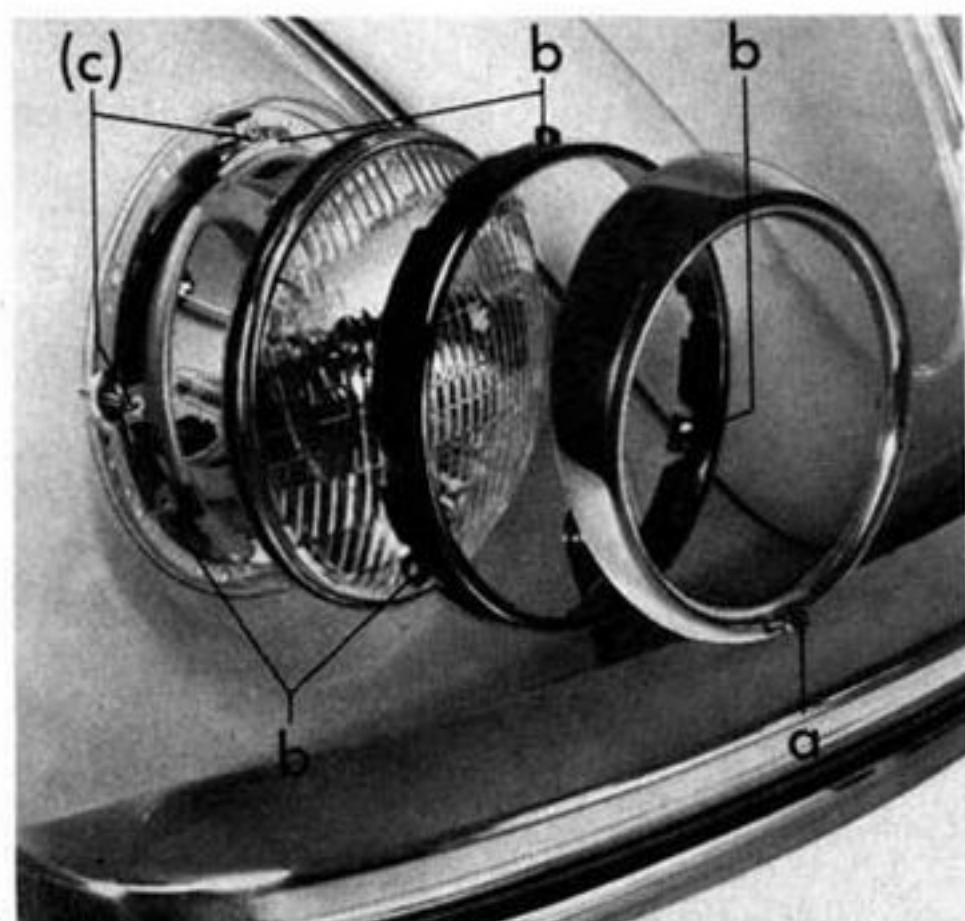

Front turn signal/parking light bulb or side marker light bulb

Remove two Phillips screws. Take off housing and lens.

Gently press bulb into holder, turn and take out.

Install new bulb.

Be sure the gasket is properly positioned when reinstalling the housing and lens.

Tighten screws evenly. Do not over-tighten as this may crack the lens.

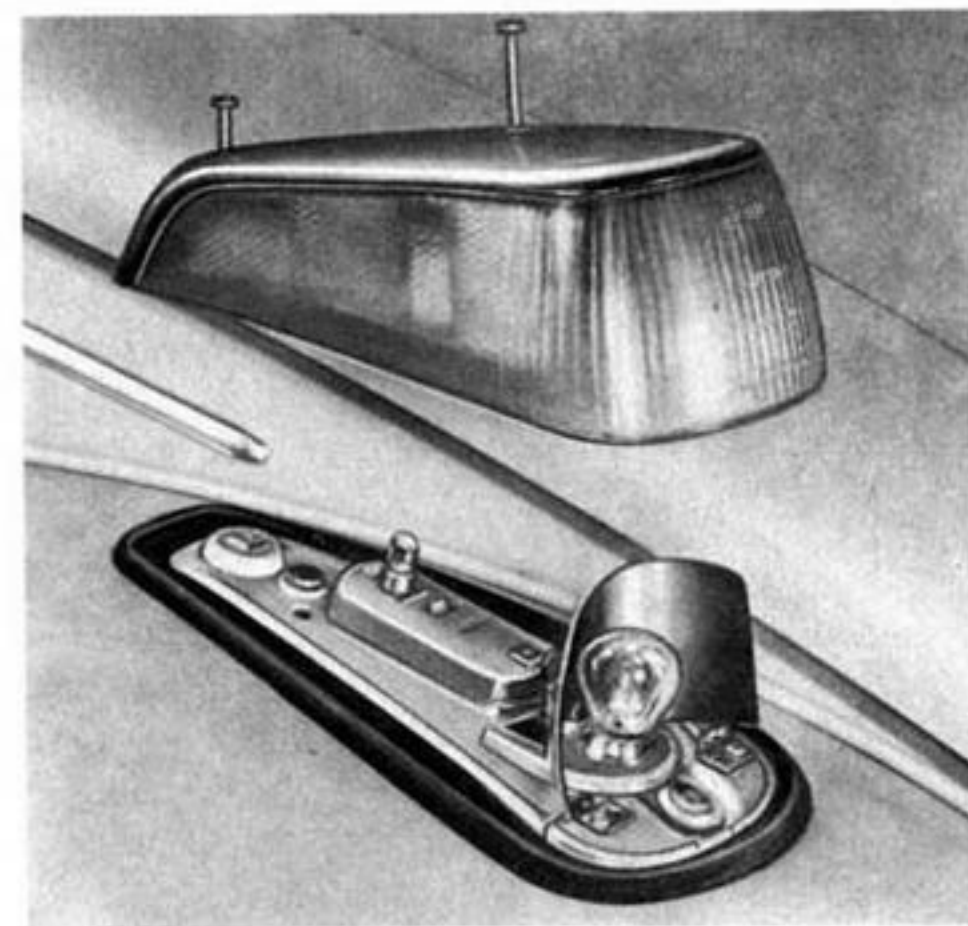

Rear turn signal, stop/tail light or back-up light bulb

Unscrew four Phillips screws and remove lens.

Bulb positions:

- a – turn signal light
- b – stop light
- c – tail light
- d – back-up light

Gently press bulb into holder, turn and take out. Install new bulb.

Be sure the gasket is properly positioned when reinstalling the lens. Tighten screws evenly. Do not overtighten as this may crack the lens.



License plate light bulb

Open rear hood.

Remove screws on each side of lens and take off lens with bulb holder.

Pull bulb holder out of lens.

Gently press bulb into holder, turn and take out.

Install new bulb.

When installing, ensure that the cable grommet fits properly.

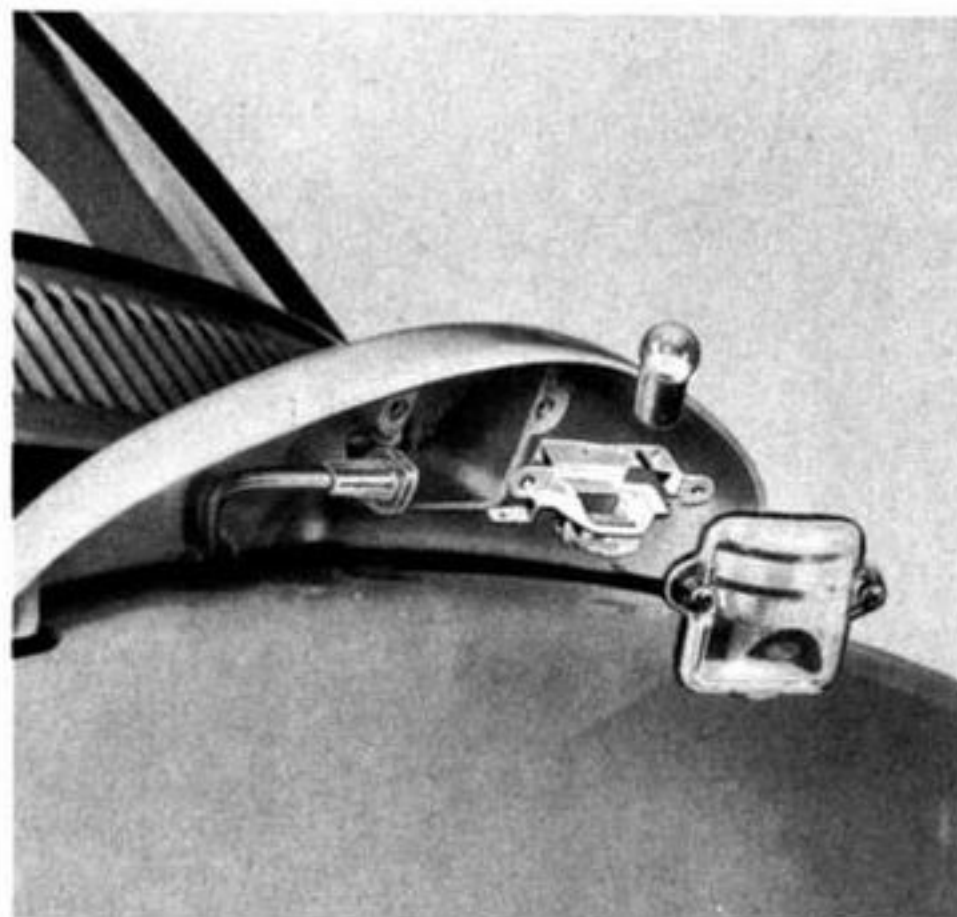

Interior light bulb

Insert screwdriver in housing cut-out on the switch side and carefully pry out.

Take bulb out.

Install new bulb.

Insert housing in reverse order.

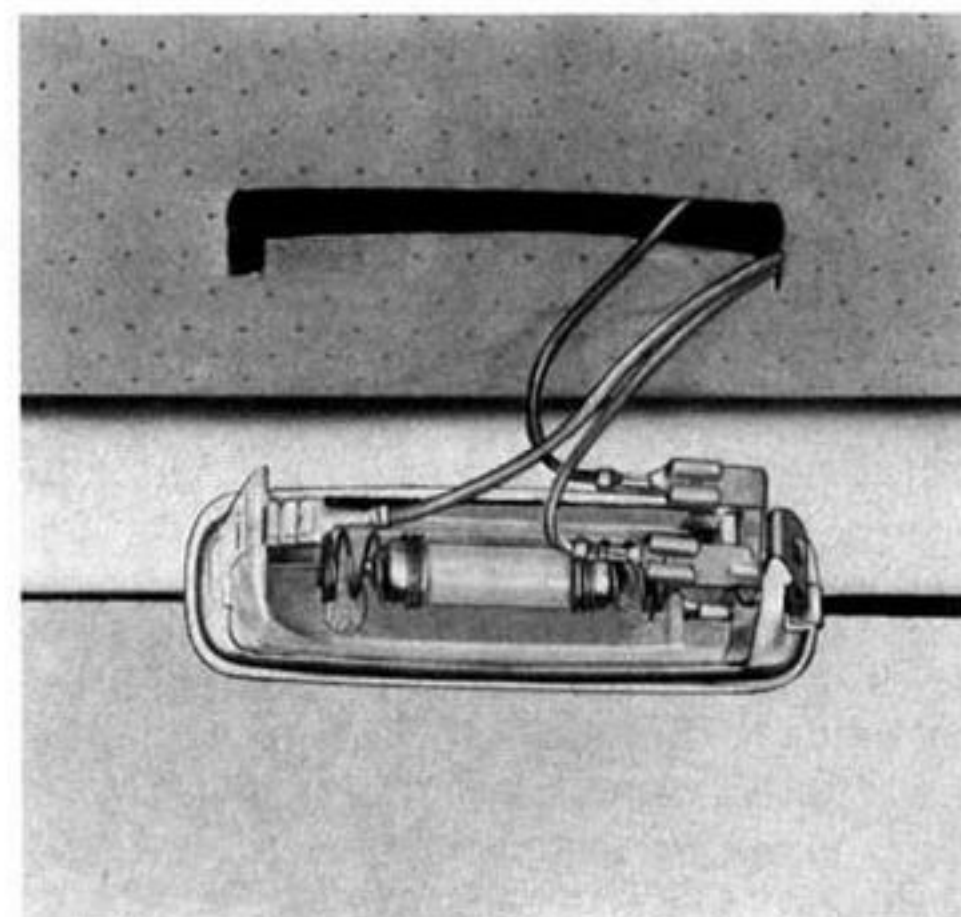

General services

Before working on any part in the engine compartment, turn off the engine and let it cool down sufficiently. If work has to be done with the engine running, exercise extreme caution to prevent neckties, jewelry or long hair from getting caught in the V-belt.

Incomplete or improper servicing may cause problems in the operation of the car. If in doubt about any servicing, have it done by your Authorized VW Dealer or any other properly equipped and qualified workshop.

Adjusting or replacing V-belt

Turn the engine off!

To adjust the belt, remove the rear half of the pulley on the alternator. When loosening and tightening the nut, place a screwdriver through the cut-out in the front half of pulley and support the screwdriver as shown in the picture.

The belt tension is adjusted by varying the number of washers between the pulley halves. Taking washers out increases the tension, putting them in decreases it. Extra washers are stored on the outside of the pulley half.

50

The V-belt must not be too tight or too loose when you are making the following belt tension check: Depress one side of the belt at the center between the two pulleys. The tension is correct if the belt can be depressed between 0.43 ($\frac{7}{16}$) in. or 11 mm and 0.55 ($\frac{9}{16}$) in. or 14 mm at a pressure of 16.5 lbs. or 7.5 kg (a firm press with your thumb).

This is only a temporary adjustment. Have final adjustment made by your dealer.

A new belt may stretch slightly at first. To compensate for this, the belt should be

a – to loosen b – to tighten

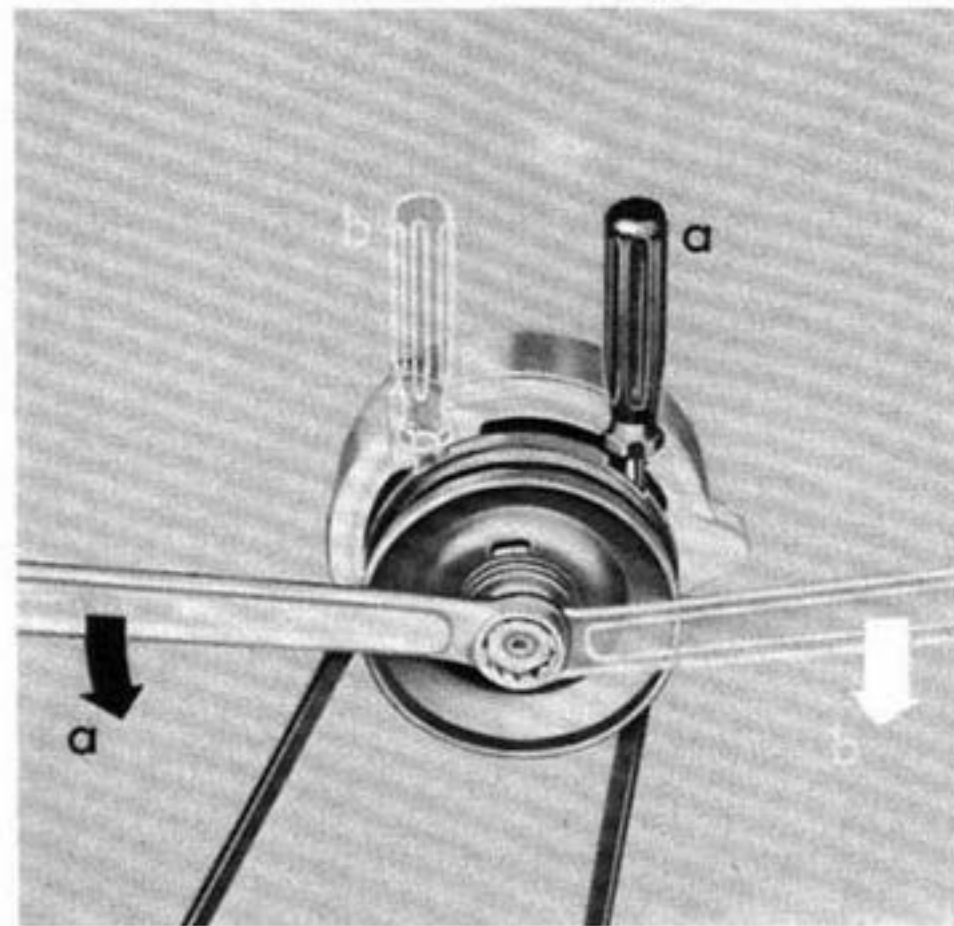

tightened slightly more when first installed. The deflection should be between 0.35 ($\frac{11}{32}$) in. or 9 mm and 0.43 ($\frac{7}{16}$) in. or 11 mm at the same pressure. The correct belt tension will then be reached after about 30 minutes of operation.

The heavy-duty V-belt has a very low stretch factor. When properly installed, the belt tension will remain fairly constant. Volkswagen-recommended V-belts have a relatively long service life, however, it is good planning to always carry a spare belt in your car.

For the correct designation on the belt, see page 60.



Cleaning or replacing spark plugs

The correct spark plug gap is 0.028 inch, or 0.7 mm. Since the spark plug gap tends to increase in time during normal operation, it is advisable to replace spark plugs periodically (see also Warranty and Maintenance booklet).

Removing spark plugs

Turn the engine off!

Grasp the spark plug connector and pull it off. Do not pull on the ignition wires as they may separate from the connectors.



Unscrew the spark plugs with a suitable spark plug wrench.

Cleaning spark plugs

Dirty spark plugs should be cleaned with a sand blaster, but if not available, the carbon can be removed with a wooden or plastic pick. Do not use a wire brush. The plugs should also be clean and dry on the outside to avoid shorting and arcing. **The gap can be set by bending the outside electrode.**

Installing spark plugs

Insert them by hand and screw them into the cylinder head as far as they will go. Only then use the spark plug wrench to tighten them firmly. Do not overtighten.

Checking the engine oil level

You should check the oil level from time to time. To get a true reading, be certain the car is on level ground.

Wait at least 5 minutes after the engine has been stopped; give the oil time to collect in the crankcase.

To check the oil level, take the dipstick out and wipe it clean first. Now, insert and pull it out again. You have enough oil in the engine if the oil level is between the upper and lower marks on the dipstick. The difference between the two marks is about 1.3 U.S. quarts (1.1 Imp. quarts or 1.25 liter).

Only add the amount of oil that is needed. Always select a well-known brand and the recommended grade. Details about the correct oil viscosities are on page 55.

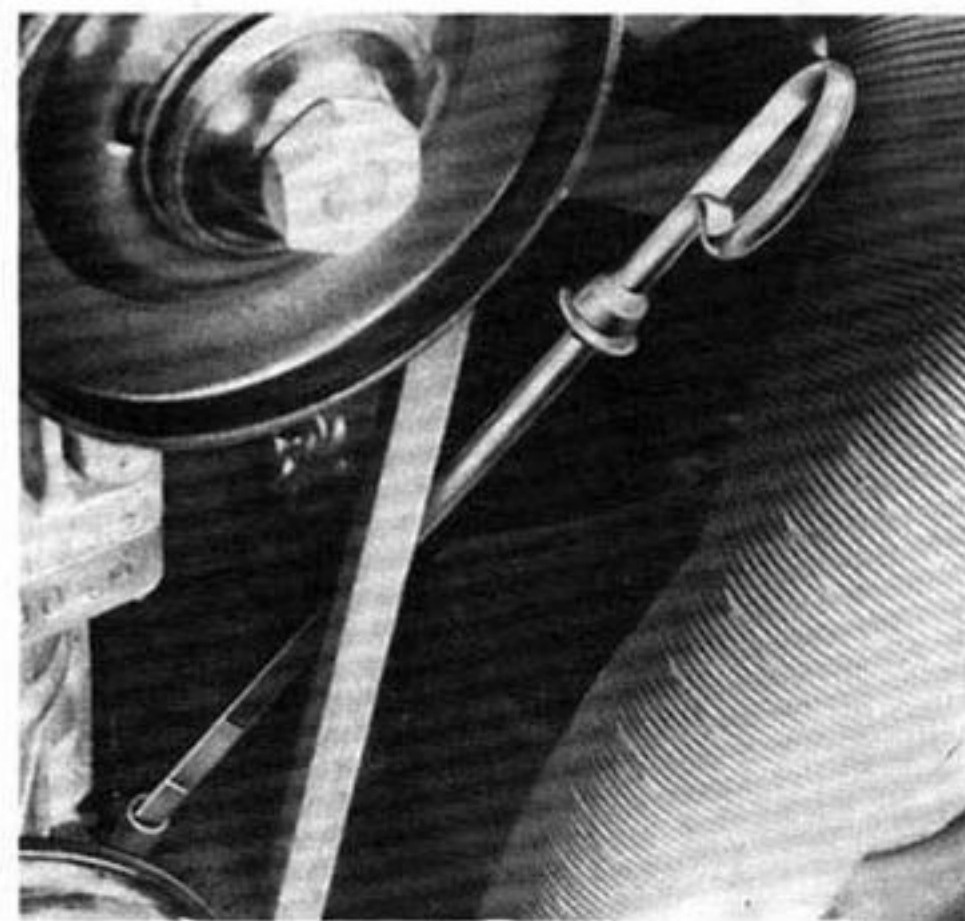

Changing the engine oil

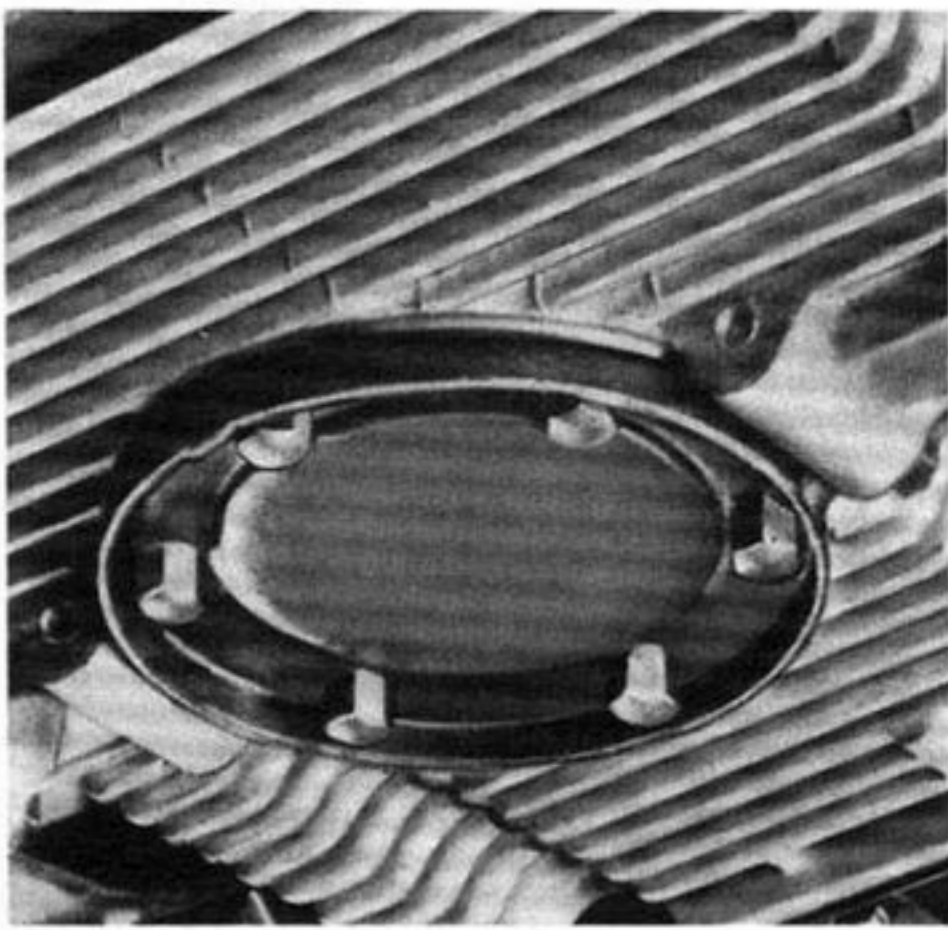

Engine off!

Change the oil in your engine regularly (see also Warranty and Maintenance booklet). This is very important as the lubricating properties of oil diminish gradually during normal operation of the car.

Drain the oil when the engine is still warm. Loosen all six cap nuts. Then, after removing five of the nuts, pry the oil strainer cover loose. Allow the oil to drain.

After the oil is drained, remove the oil strainer to clean it. The cleaning of the strainer should be done with every oil change. Use new gaskets and washers when re-installing the strainer to be sure no oil leak will develop later.

Tighten cap nuts in a crosswise pattern to a torque of 5 ft. lbs. (0.7 mkg).

Fill the engine with 2.6 U.S. quarts (2.2 Imp. quarts or 2.5 liters) of oil labeled "For Service API/SE". For the right oil viscosity, see page 55.

When putting the threaded cover (arrow) back on, turn it clockwise, but do not overtighten.

Because of detergent additives in the oil the fresh oil will look dark after the engine has been running for a short time. This is to be expected, and there is no

reason to change the oil at intervals shorter than recommended by the manufacturer.

We recommend more frequent oil changes if you drive your car only short distances during the winter months.

Be mindful of how you dispose of the engine oil. Do not dump it in streams or down sewage drains. Check your local ordinances.

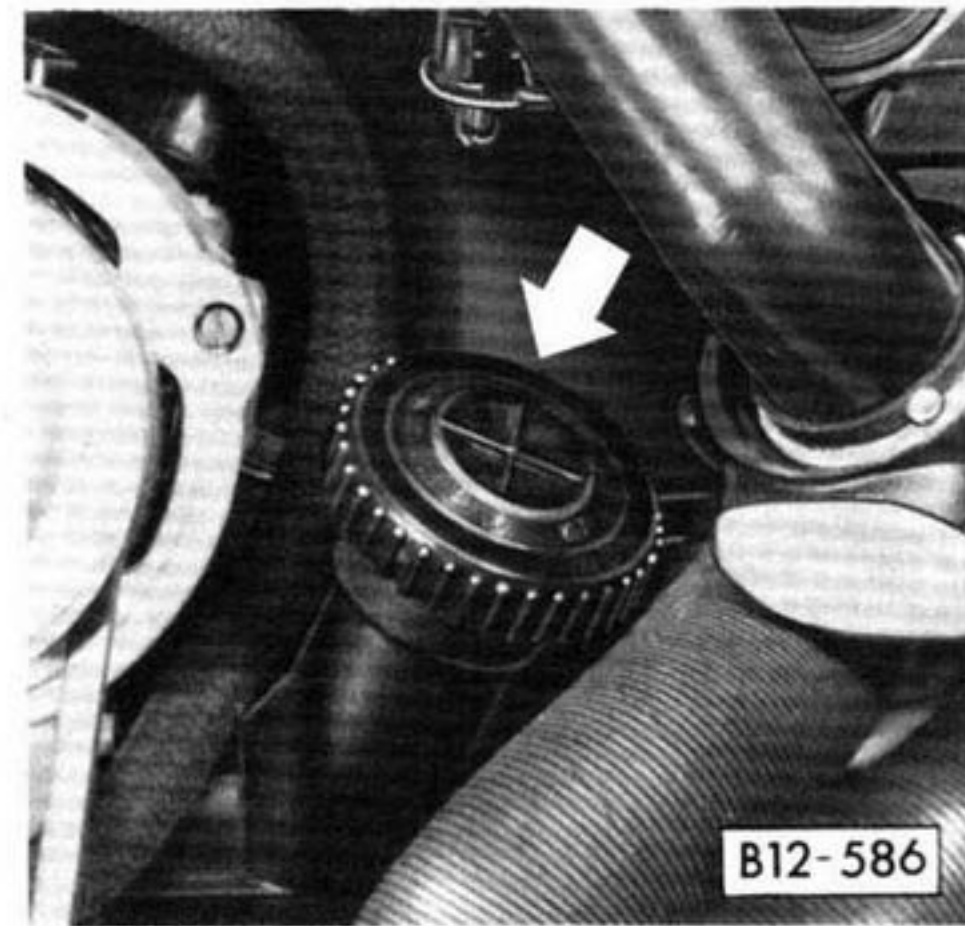

Transmission Oil

Both transmission and final drive are combined in one housing. The lubricant used is hypoid oil which does not have to be changed.

Should the need arise to add oil, it should only be done with the necessary workshop equipment.

Air Cleaner

All the dust present in the air drawn in by the engine is retained by the filter element in the air cleaner.

A dirty filter element not only reduces the engine output but can also cause premature engine wear. Under normal conditions it is not necessary to service the filter element more frequently than is mentioned in the Warranty and Maintenance booklet. If local conditions are such that the vehicle is often driven on very dusty roads, the cleaner must be serviced more frequently, even daily if necessary.

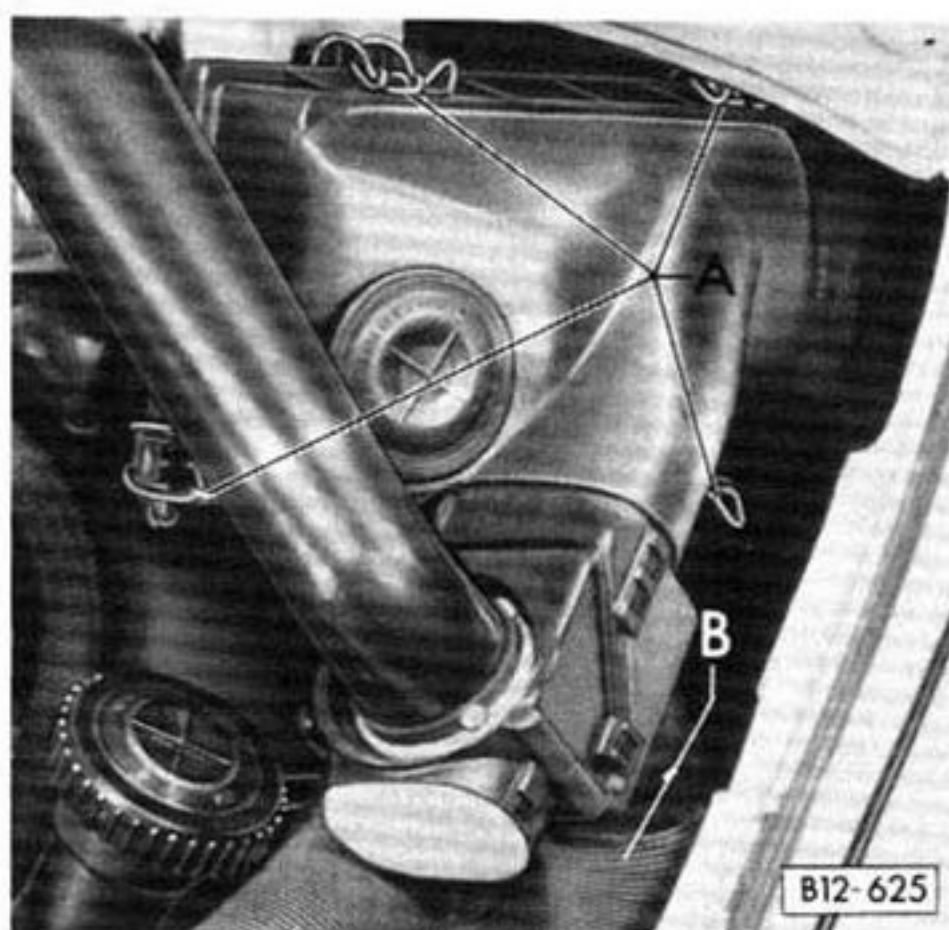

To clean or to replace the filter element, do the following:

Release the four clips –A– and take top part of air cleaner off.

Pull hose –B– off.

Take the filter element out and clean or replace it. Remove the dirt by shaking the filter element out, with the dirt-trapping side down.

Note

Under no circumstances may the paper element be cleaned or soaked with gasoline, cleaning solvents or oil.

When installing the air cleaner, make sure the element is properly seated and hose –B– is properly connected.

Lubrication

Front axle

(Applies to the Beetle only. The front axle of the Convertible does not have to be lubricated.)

Lubricate the front axle once a year or at the specified mileage intervals (see Warranty and Maintenance booklet).

Lift the front end of the car to take the weight off the front wheels. This is necessary to free the bearings to accept the lubricant. There are 4 grease fittings for the front axle. For their location, see arrows in the illustration.

Before forcing grease into the fittings, be sure to wipe them clean with a piece of cloth. Force lithium-based multi-purpose grease into the fittings until fresh grease starts to emerge at the torsion arm sealing rings.

Wipe off any grease or oil that may have come in contact with tires or brake hoses because grease and oil have an adverse effect on rubber.

Door hinges and locks

The door hinges have to be lubricated at specified intervals (see Warranty and Maintenance booklet). Your Authorized VW Dealer uses a grease gun with a tapered nozzle.

If upon inspection the door locks are not working properly they should be lubricated with a few drops of oil after the plug has been removed from the access hole.

To lubricate the lock cylinder dip the key into graphite, insert it and turn it a few times in the lock.

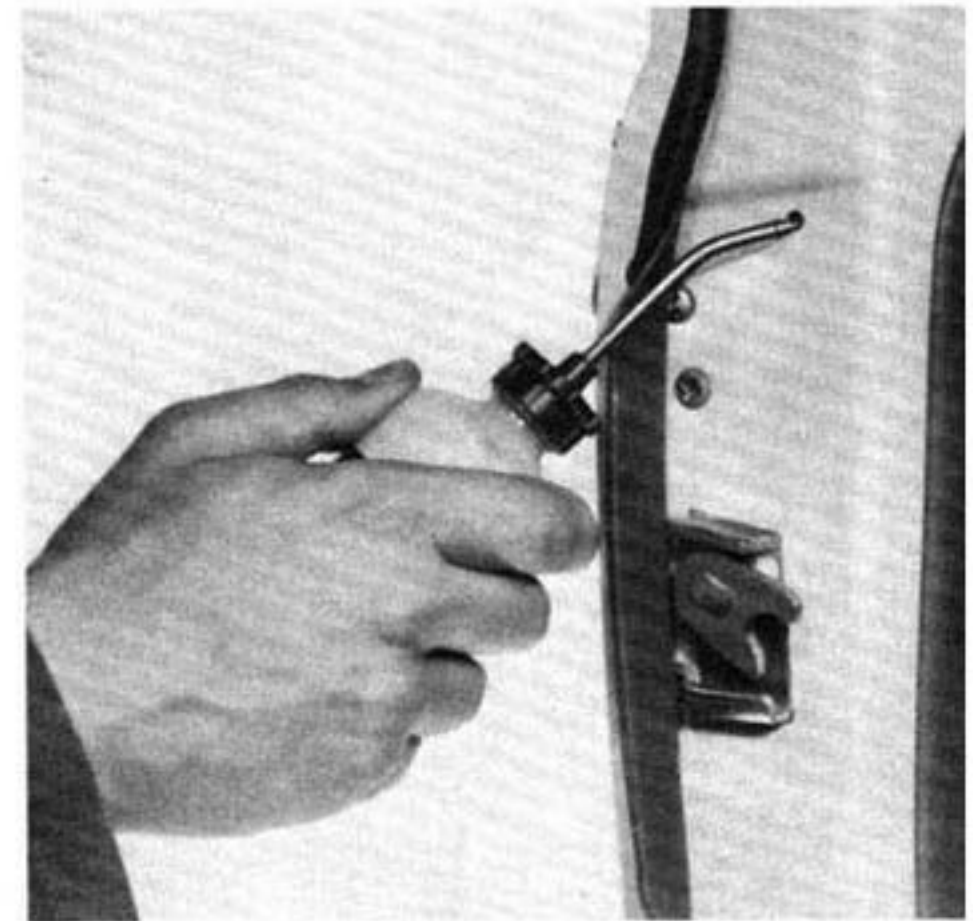
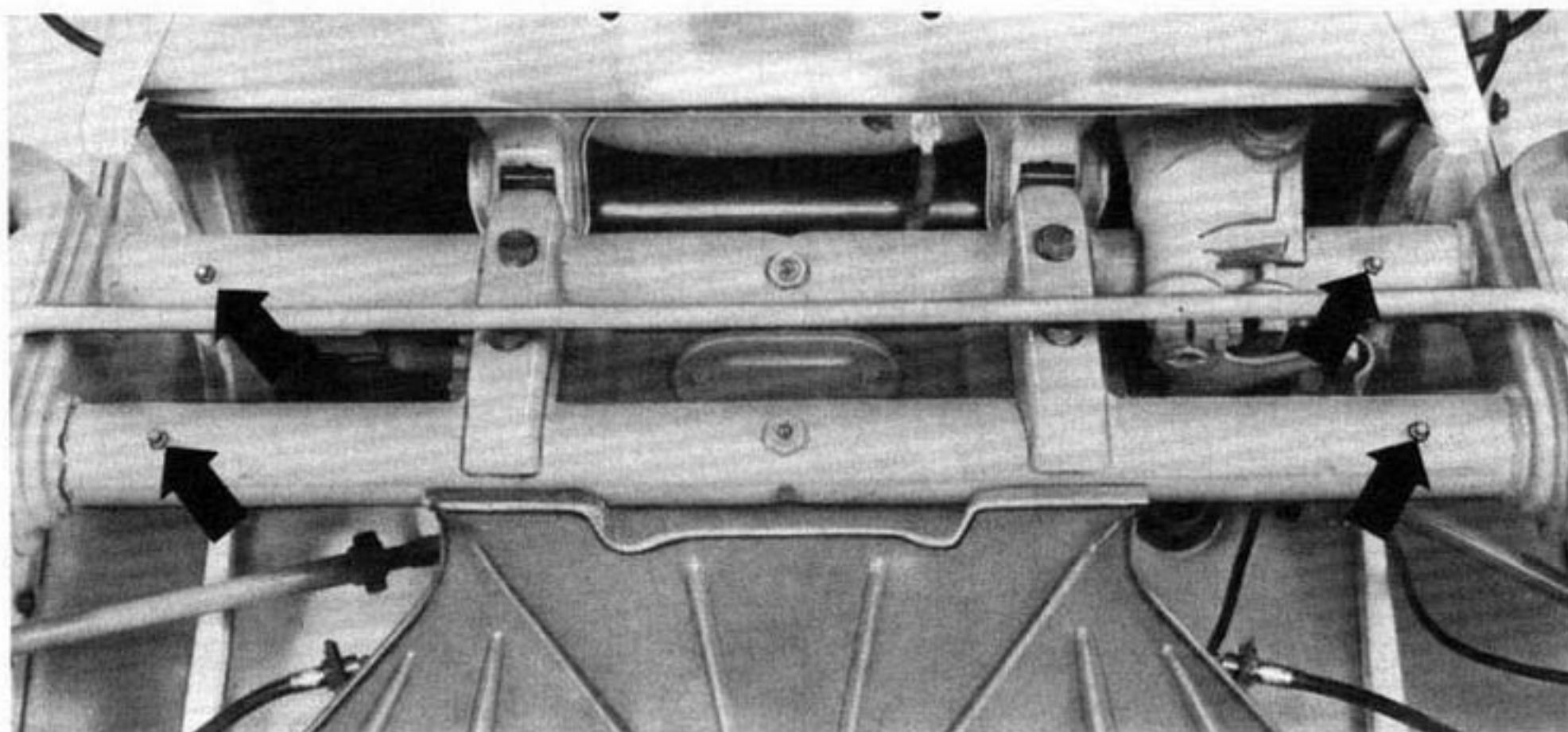

Lubricants

Engine oil

The table on the right contains the grading for oils to be used in your VW engine.

Always use a name brand oil labeled "For Service API/SE" for the engine of your Volkswagen.

Engine oils are graded according to their viscosity. The proper grade to be used in your engine depends on existing climatic or seasonal conditions.

As temperature ranges of the different oil grades overlap, **brief** variations in outside temperatures are no cause for alarm. It is also permissible to mix oil of different viscosities if you find it necessary to add oil.

Transmission oil

In general all year round, the transmission of your Volkswagen requires hypoid oil SAE 80 W or SAE 80 W/90 (multigrade) according to MIL – L 2105 API/GL 4 specifications. This hypoid oil does not have to be changed.

Lubricant additives

If your Volkswagen is properly maintained, it is uneconomical to mix any type of additive with fuel or lubricating oils.

Grease

- 1 – **Multi-purpose grease with a lithium base** should be used for the front axle of the Beetle and for the door hinges on all beetle-type VW models.
- 2 – **Dry stick lubricant** should be used for the hood locks and the sliding surfaces of the striker plates.
- 3 – **Silicone spray or petroleum jelly** should be used for the battery terminals and posts.

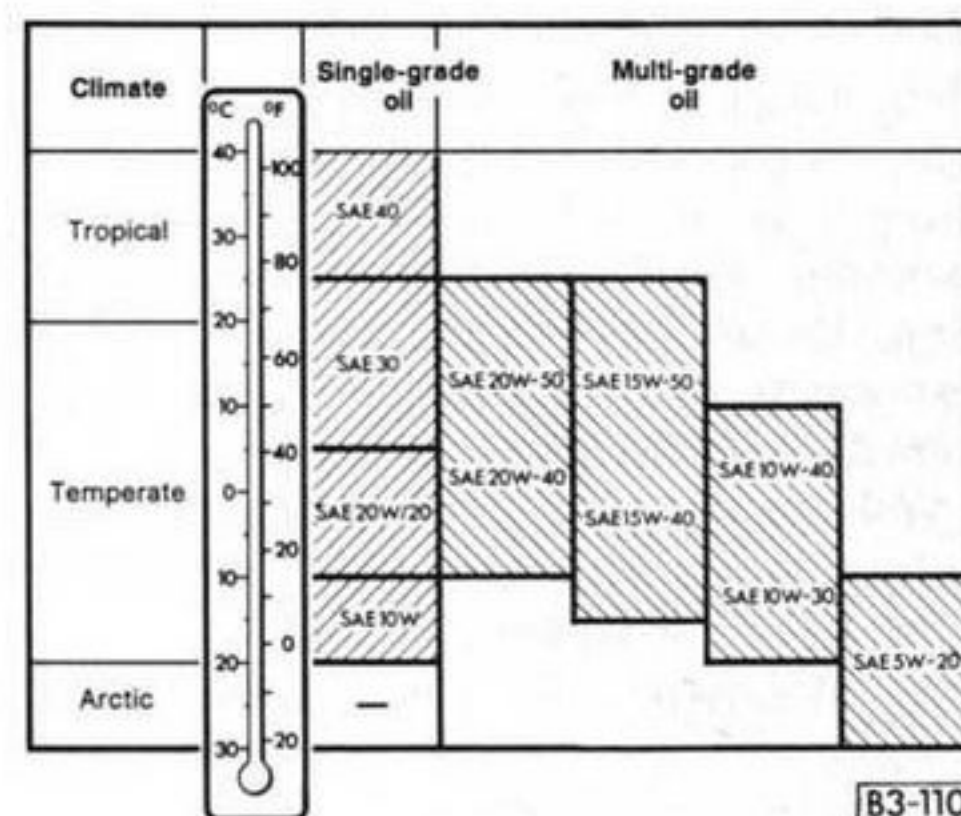

When using single grade SAE 10 W or multi grade SAE 5 W-20 engine oil avoid high speed long distance driving if the outside temperature rises above the indicated limit.

Troubleshooting

Your Volkswagen should repay you with trouble-free driving if it receives regular maintenance.

Should you ever encounter difficulty in starting your engine or have trouble on the road, there are a few repairs which you can make to get your VW going again. Locate the problem and probable cause of the trouble in the guide on the following pages and follow the directions on what to do.

Exercise extreme caution when working on any part of the car to prevent accidental injury. To prevent sparking or accidental fires, disconnect battery ground cable when working on the electrical or fuel systems. Incomplete or improper servicing may also cause problems in the operation of the car. If in doubt about any servicing, have it done by a qualified mechanic or by your Authorized VW Dealer.

If you are not fully familiar with proper repair procedures, do not attempt the checks or repairs described on this page.

Note: The adjustment of idling and ignition timing requires special equipment and training. We suggest that you consult your Authorized VW Dealer.

Problem	Probable Cause	What To Do
A – VW will not start; engine will not turn over or turns over too slowly	<ol style="list-style-type: none"> 1. Run down or dead battery 2. Loose connection <ol style="list-style-type: none"> a. At battery b. At starter c. At connections behind dashboard 3. Starter defective 	<ol style="list-style-type: none"> 1. Charge or replace battery. 2. Make sure that all connections are tight. <ol style="list-style-type: none"> a. Check both cable connections on battery and grounded end of ground strap. b. Check connections at solenoid, mounted on starter, under right rear of vehicle. c. Check push-on connectors behind dashboard. 3. See your nearest Authorized VW Dealer.
B – VW will not start; engine turns over	<ol style="list-style-type: none"> 1. Loose connection in ignition system 2. Loose connection in primary circuit to coil 3. If spark is present at black coil cable, trouble is in ignition system 	<ol style="list-style-type: none"> 1. Check for loose connections at coil, distributor and spark plugs. 2. Check push-on connector on coil (thin black wire). Check push-on connectors behind dashboard. Should the engine not start, ask for assistance. 3. Check in this sequence: <p>Caution: Always disconnect white cable from coil connector No. 1 (marked on coil). This stops the fuel injection with the ignition switched on. Excess fuel may damage the catalytic converter.</p> <ol style="list-style-type: none"> a. Turn ignition off. Remove distributor cap and rotor. Clean distributor contacts with stiff paper (post card). Have someone turn engine over with starter. Sparks should be visible between contacts. If no spark, check contact of cable connectors between coil and distributor cap. Check if contacts open. If there is still no spark, see your nearest Authorized VW Dealer.

Problem	Probable Cause	What To Do
B – VW will not start: engine turns over	4. If spark is fairly good at plugs, the engine may be flooded.	<p>b. If sparks are visible between contacts disconnect high tension cable from center connection of distributor cap. With starter cranking the engine point cable to a metal object in the engine leaving a gap of approximately $\frac{1}{4}$". Strong arcing sparks should appear. If there are no sparks, contact your nearest Authorized VW Dealer.</p> <p>c. If sparks appear at high tension cable, the distributor cap should be cleaned inside and out. Reconnect high tension cable. Remove one of the spark plugs. If plug is clean and dry, reconnect ignition cable to spark plug and bring spark plug into contact with metal (ground). Hold cable with dry piece of cloth to avoid shock. Sparks should appear between spark plug electrodes when the engine is turned over. If not, clean and dry ignition cables and spark plug connectors and check that ignition cables are tight in distributor cap and plug connectors. Ask for assistance if the above steps did not ensure proper ignition.</p> <p>4. If the spark plug is dirty and wet, also remove the other plugs: unburned gasoline on the plug electrodes indicates excessive fuel supply! Turn engine over for at least 10 seconds, with plugs removed, white cable disconnected from coil connector No. 1 and accelerator pedal fully depressed. Install cleaned and dried spark plugs or new plugs, if necessary. Reconnect the white cable and start engine. If engine still does not start, ask for qualified assistance.</p>
C – Engine stalls shortly after starting	Poor fuel supply	See paragraphs D 2 and D 3.
D – Engine stalls while vehicle is driven	<ol style="list-style-type: none"> 1. Defect in ignition system 2. Fuel supply is exhausted 3. Fuel filter may be clogged, gasoline may be contaminated by water or dirt. 	<ol style="list-style-type: none"> 1. See paragraph B 1 through B 3. 2. Check whether any gasoline is left in tank. 3. See your VW dealer for cleaning of all components of the fuel system.
E – Red warning light for oil pressure comes on while you are driving	If light goes on, the oil pressure is too low	Stop at once and check oil level. Add oil as necessary. If the oil level is sufficient and light goes on while driving, contact the nearest Authorized VW Dealer before driving on.
F – Red warning light for alternator and cooling comes on while you are driving	<ol style="list-style-type: none"> 1. Fuse 12 in the fuse box (see page 43) may be blown 2. If light goes on, V-belt may be broken or alternator does not charge 	<ol style="list-style-type: none"> 1. Replace fuse. If it blows again, do not drive on, because the turn signals will not work. Ask for assistance. 2. If belt drives alternator without slipping, switch off all unnecessary electrical equipment (radio, etc.). Drive to nearest VW dealer as otherwise the battery will soon run down. If belt is broken, replace it before driving on because engine cooling fan is no longer working.

Technical data

Engine

Four cylinder, four stroke, horizontally opposed, in rear.

Air cooling by fan, thermostat-controlled. Pressure oil feed with gear-type pump.

Oil cooler. Electric fuel pump. Electronically controlled fuel injection.

Paper element air cleaner with temperature sensitive intake air pre-heating.

Exhaust emission control system. Activated charcoal filter in the fuel system.

Bore 3.36 in. (85.5 mm)

Stroke 2.72 in. (69 mm)

Displacement 96.6 cu. in. (1584 cc)

Compression ratio 7.3 : 1

Maximum output SAE net 48 hp at 4200 rpm.

Maximum torque SAE net 75 lb. ft. at 2200 rpm.

Valve clearance with engine cold Intake and exhaust 0.006 in. (0.15 mm)

Fuel rating* **VWs with catalytic converter: Unleaded fuel only. All other VWs: "Regular",**
incl. low-lead or unleaded fuels.
See also pages 42 and 43.

* The minimum fuel octane rating for your VW engine is listed on a sticker on the inside of the fuel tank flap.

Transmission

Single plate, dry clutch.

Clutch pedal free play: $\frac{3}{8}$ – $\frac{3}{4}$ in. (10–20 mm)

Baulk synchronized four-speed transmission and bevel gear differential in one housing.

Drive shafts with two constant velocity joints per shaft.

Platform frame with tunnel shaped center member; engine/transmission unit bolted to rear frame fork. Front axle bolted to frame head.

Independent wheel suspension, trailing arms and diagonal links at rear.

Torsion arms with stabilizer at front.

Springing: torsion bars at rear, telescopic shock absorbers both front and rear. Torsion bars at front.

Steering (energy absorbing) with maintenance free tie rods. Roller steering with hydraulic steering damper.

Hydraulic dual circuit foot **brakes** with drums at front and rear; mechanical parking brake effective on rear wheels.

Wheelbase 94.5 in. (2400 mm)

Turning circle, curb to curb 34.4 ft (10.5 m)

Track at front 51.5 in. (1308 mm)

Track at rear 53.1 in (1349 mm)

Wheels 4½ J x 15 safety rim wheels

Tires, tubeless. Bias Ply Tires

Tire size and pressures . . . Tire size and VW-recommended cold tire inflation pressures are listed on a sticker on the inside of the glove compartment door.

Platform frame with tunnel shaped center member; engine/transmission unit bolted to rear frame fork. Frame head for front suspension attachment.

Independent wheel suspension, trailing arms and diagonal links at rear.

Suspension struts at front, attached to frame head by track control arms and stabilizer.

Springing: torsion bars at rear, telescopic shock absorbers both front and rear. Coil springs at front.

Steering (energy absorbing) with maintenance free tie rods. Rack and pinion steering.

Hydraulic dual-circuit foot **brakes** with drums at front and rear; mechanical parking brake effective on rear wheels.

95.3 in. (2420 mm)

29.5 ft. (9 m)

54.9 in. (1394 mm)

53.1 in. (1349 mm)

Electrical system

Voltage	12 volts
Battery	45 Ah
Starter	0.7 bhp
Alternator	700 watts (14 volts/50 amp.)
V belt size	11.3 x 912 LA "XDA" ("DA" = low stretch factor)
Ignition distributor	with combined vacuum and centrifugal spark advance
Firing order	1 - 4 - 3 - 2
Ignition timing	for correct specifications for your engine, see label in engine compartment
Contact breaker gap	0.016 in. (0.4 mm)
Spark plugs	Bosch W 145 M 1, Beru 145/14 L, Champion L 288
Plug thread	14 mm
Electrode gap	0.028 in. (0.7 mm)

Dimensions and weights

	Volkswagen Beetle		Volkswagen Convertible	
	Length	163.4 in.	(4150 mm)	164.8 in.
Width	61.0 in.	(1550 mm)	62.4 in.	(1585 mm)
Height	59.1 in.	(1500 mm)	59.1 in.	(1500 mm)
Ground clearance	5.9 in.	(150 mm)	5.9 in.	(150 mm)
Vehicle capacity weight *	see sticker on the inside of the glove compartment door			
Gross vehicle weight	} see Safety Compliance Sticker on the left doorjamb (see also page 7).			
Gross axle weight, front				
rear				
Permissible roof weight**	110 lbs.	(50 kg)	—————	
Permissible trailer weights:				
Trailer without brakes	882 lbs.	(400 kg)	882 lbs.	(400 kg)
Trailer with brakes	1433 lbs.	(650 kg)	1433 lbs.	(650 kg)
Trailer tongue load	55-110 lbs.	(25-50 kg)	55-110 lbs.	(25-50 kg)

* Less, if an VW Air Conditioner is installed (see page 32)

** Applies only to roof rack mounted to rain gutters. Distribute load evenly!

Capacities

	U.S.	Imp.	Metric	
Fuel tank:				VWs with catalytic converter: Unleaded fuel only. All other VWs: "Regular", incl. low-lead and unleaded fuels (see also pages 42 and 43).
Beetle	10.6 gal.	8.8 gal.	40 liters	
Convertible	11.5 gal.	9.2 gal.	42 liters	
Engine	2.6 qts.	2.2 qts.	2.5 liters	Engine oil "For Service API/SE" (see page 55)
Transmission: at oil change	2.6 qts.	2.2 qts.	2.5 liters	Hypoid oil * (see page 55)
Windshield washer container:				Fluid (see page 41)
Beetle	1.8 qts.	1.5 qts.	1.7 liters	
Convertible	2.1 qts.	1.8 qts.	2.0 liters	
Operating pressure	42 psi	42 psi	3.0 kg/cm ²	

* Does not have to be changed.

Performance

Maximum and cruising speed. 81 mph

Emission Control System

In the Interest of Clean Air

Pollution of our environment is of increasing concern to all of us. We urge you to join us in our efforts for cleaner air in controlling the pollutants emitted from the automobile.

Volkswagen has long recognized its responsibilities not only toward its customers but also toward the public in general. We have developed an emission control system that controls or reduces those parts of the emission that can be harmful to our environment. Your Volkswagen is equipped with such a system.

Volkswagen warrants the emission control system in your vehicle under the terms and conditions set forth in the Warranty and Maintenance booklet. You, as the owner of the vehicle, have the responsibility to provide regular maintenance service for the vehicle, as specified in the maintenance schedule, and to keep a record of all maintenance work performed. Authorized Volkswagen dealers have VW trained mechanics and special tools to offer fast, efficient service.

High/low altitude operation

Cars sold in high or low altitude areas are adjusted for proper operation at the respective altitude.

If you should move for an extended period of time from a low to a high altitude area (4000 feet/1220 meters above sea level), or vice versa, the vehicle engine must be readjusted for operation at the respective altitude by your authorized dealer.

How Emission Control Works

When an automobile engine is running, it uses energy generated through the combustion of a mixture of air and fuel. Depending on whether a car is driven fast or slow or whether the engine is cold or hot, some of the fuel (hydrocarbons) may not be burned completely but be discharged into the engine crankcase or exhaust system. Additional hydrocarbons may enter the atmosphere through evaporation of fuel from the fuel tank. These hydrocarbons released into the air contribute to undesirable pollution.

In addition, carbon monoxide (CO) and oxides of nitrogen (NOx) contribute to harmful engine emissions. They, too, are formed during combustion and discharged into the exhaust system.

To reduce these pollutants all Volkswagens are equipped with a special emission control system.

Your Volkswagen may have all or part of the following major components:

Controlled Combustion System

The amount of pollutants emitted from an engine greatly depends on the combustion of the air/fuel mixture. Complete burning of the air/fuel mixture is, therefore, very important. An improved combustion process in your Volkswagen makes it possible to keep harmful emissions from the engine at the required low level.

Your Volkswagen is equipped with a precisely calibrated fuel injection system to assure a finely balanced air/fuel mixture under all operating conditions.

Crankcase Ventilation

Through crankcase ventilation harmful emissions from the engine crankcase are not permitted to reach the outside atmosphere. These emissions are recirculated to the air cleaner. From here the emissions mix with the air/ fuel mixture in the intake system and are later burned in the engine (see illustration).

Exhaust Gas Recirculation (EGR)

Some of the exhaust gas from the engine is diverted before it enters the muffler. This gas is routed back into the intake manifold. An exhaust gas recirculation valve controls the flow to the intake manifold. The exhaust gas recirculated into the combustion chambers of the engine helps lower the formation of oxides of nitrogen (NOx) during the combustion process (see illustration).

Catalytic Converter (where applicable)

The catalytic converter is an efficient "clean up" device built into the exhaust system of your car to further help reduce engine pollutants. Harmful carbon monoxide and hydrocarbons in the exhaust gas are chemically changed into harmless carbon dioxide and water vapors before they pass to the outside through the muffler (see illustration).

The use of **unleaded fuel**, however, is **critically important** for the life of the converter. Deposits from leaded gasolines and fuel additives containing sulfur, zinc, nickel or barium will ruin the catalyst and make it ineffective as an emission clean-up device. Therefore, **only unleaded gasoline without harmful additives must be used.**

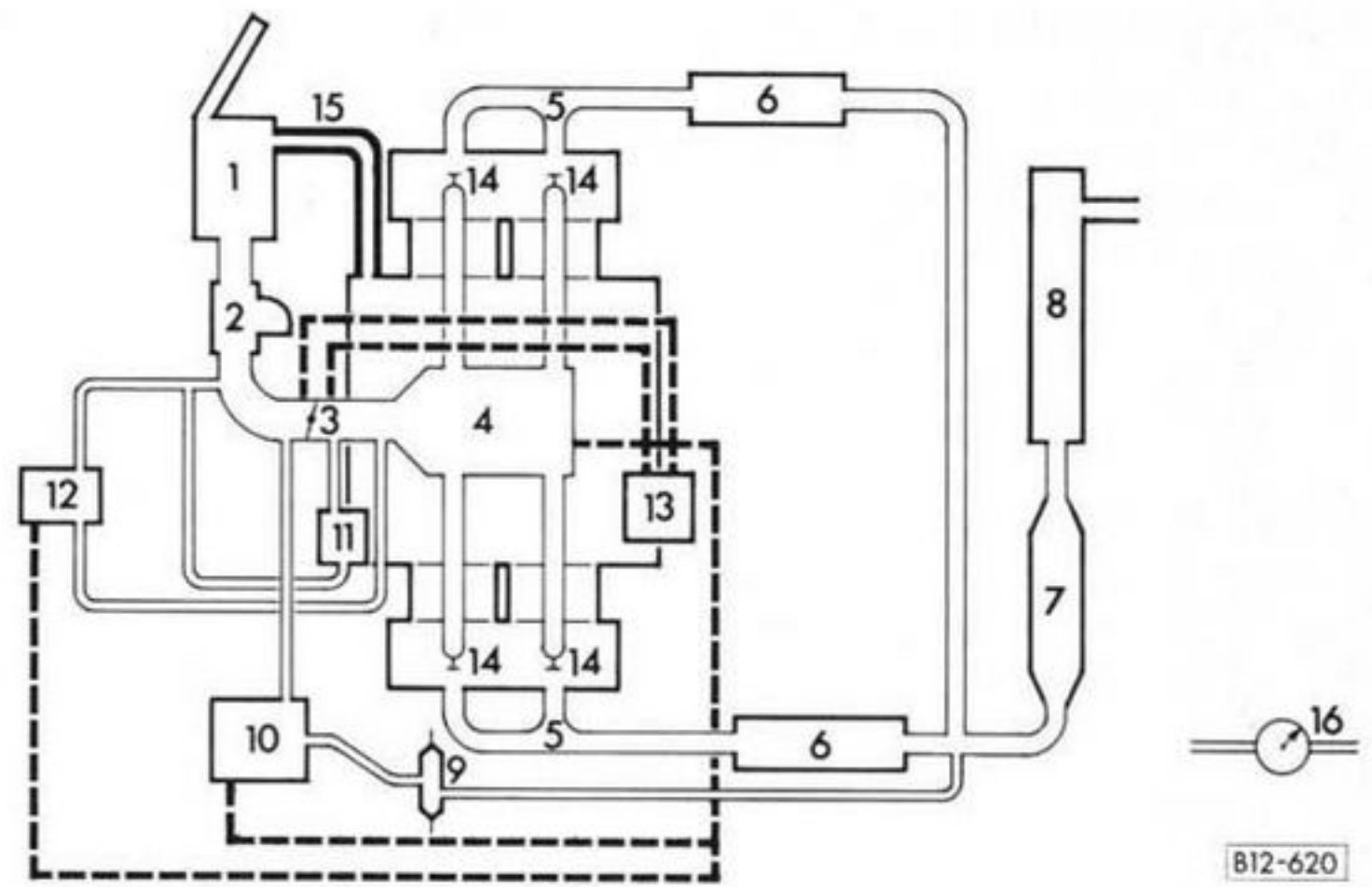

Emission Control System

- | | |
|-------------------------------------|------------------------------|
| 1 – Air cleaner | 11 – Auxiliary air valve |
| 2 – Air metering device | 12 – Decel. control valve |
| 3 – Throttle valve unit | 13 – Distributor |
| 4 – Intake manifold | 14 – Fuel injection valves |
| 5 – Exhaust manifolds | 15 – Crankcase ventilation |
| 6 – Heat exchangers | 16 – Indicator light for EGR |
| 7 – Catalyst (Catalytic converter)* | * where applicable |
| 8 – Muffler | |
| 9 – EGR-filter* | |
| 10 – EGR-valve | |
- Exhaust and air lines
- - - - -
Control lines (vacuum)

Fuel Evaporation Control

The sealed Volkswagen fuel evaporation system prevents gasoline vapors from escaping to the atmosphere through the following controls:

Fuel tank venting

A separator for the fuel tank and vent lines are part of the fuel tank vent system. These components prevent fuel from escaping to the outside at extreme high outside temperatures and when the car is driven or parked at an incline or in any other non-level position.

Carbon canister

Vapors from the fuel tank are trapped in a canister filled with carbon. This canister is also connected to the fuel tank vent system.

This is how it works:

Fuel vapors pass through the carbon canister and deposit hydrocarbons on the surface of the carbon. When the engine is running, fresh air entering the carbon canister through an opening cleans the carbon and routes the hydrocarbons via the air cleaner back to the engine where they are burned during normal combustion.

64 How fuel evaporation control works is shown in the illustration.

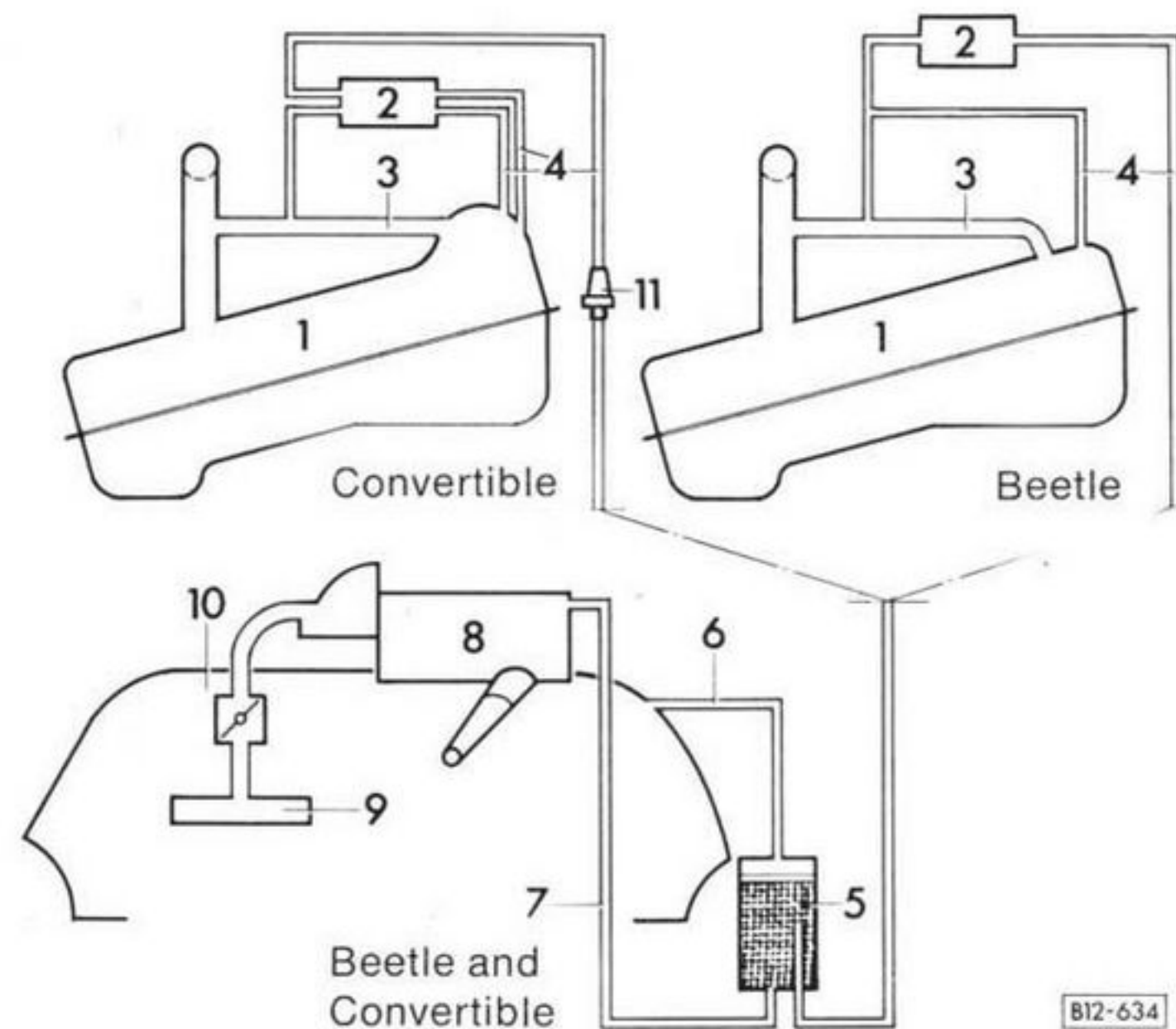

- | | |
|--|--|
| 1 – Fuel tank
(Convertible: with expansion chamber) | 5 – Carbon canister |
| 2 – Fuel expansion tank (separator)
(Convertible: Separator only) | 6 – Canister vent line (pressure) |
| 3 – Filler vent line | 7 – Canister vent line (vacuum) |
| 4 – Fuel tank vent lines | 8 – Air cleaner |
| | 9 – Intake manifold |
| | 10 – Fan housing |
| | 11 – Gravity controlled shut-off valve
(Convertible only) |



Gas Station Information

Gas Station Information

Starting

Start in Neutral only.

It is not necessary to depress the accelerator pedal when starting. Electronic fuel injection automatically provides correct fuel/air mixture for starting.

Chassis number (Serial No., VIN)

Visible through driver's side of windshield.

Front seats

Seat adjustment:
Pull lever – A –
in front of seat

Backrest release:
Lift lever – B –
on outboard side
of backrest.

A = Seat
adjustment

B = Backrest
release

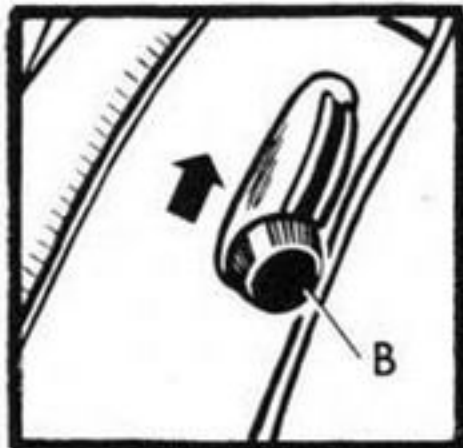
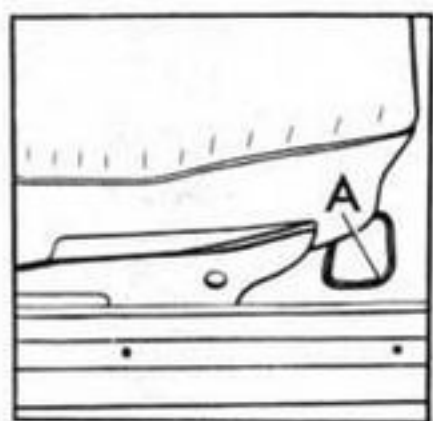

Fuel cap

Above right front fender. To close, turn cap until it clicks.

Fuel recommendation

VWs with catalytic converter:
Unleaded fuel only.

All other VWs:

"Regular", incl. low-lead or unleaded fuels.

Engine oil dipstick

Check oil level 5 min. after engine has stopped. Level should be between upper and lower marks on dipstick. Difference between marks is approx. 1.3 U.S. qts. (1.1 Imp. qts. or 1.25 liter).

C = Oil dipstick

D = Dipstick with
min. and max.
marks

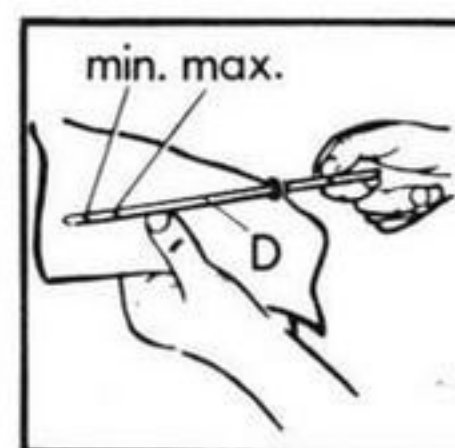
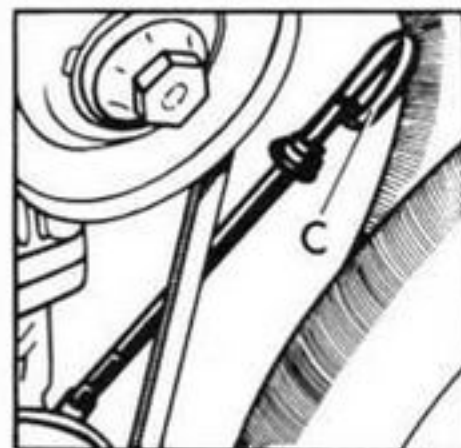

Engine oil grades

Use quality oil labeled "For Service API/SE". See oil viscosity chart on page 55.

Transmission oil

Transmission and final drive have a lifetime filling of hypoid oil Mil-L-2105 API/GL 4 SAE 80 W or SAE 80 W/90 (multi grade) all year.

E = Engine
oil filler cap

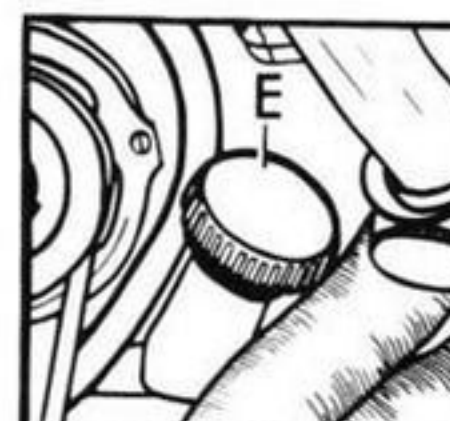

Fuse box

Under dashboard

Additional fuses for:

Back-up lights – in engine compartment above ignition coil.

Rear window defogger (main current) – under rear seat on left.

See page 44.

Hood release, front

Pull release inside glove compartment. To lock hood, lower hood, press handle down firmly until hood locks.

Brake fluid reservoir

Under front hood.

Only use new brake fluid SAE J 1703, conforming to Mot. Veh. Safety Std. 116.

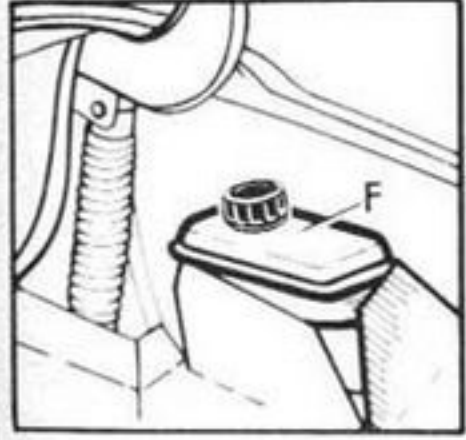

Brake fluid level should be above seam edge near top (F).

Tire pressure

See sticker on inside of glove compartment door.

Spare wheel

Under front hood

Spare tire supplies pressure to operate washer. Maintain at 42 psi (3 kg/cm²). Disconnect hose from valve (G). Pressurize spare tire by this valve.

Spare tire removal

Disconnect windshield washer hose from tire valve (**Beetle** – also remove wedges from wheel rim/arrows).

Windshield washer container

Unscrew cap (H), add water and cleaning solution. Follow mixture instructions on can.

Beetle

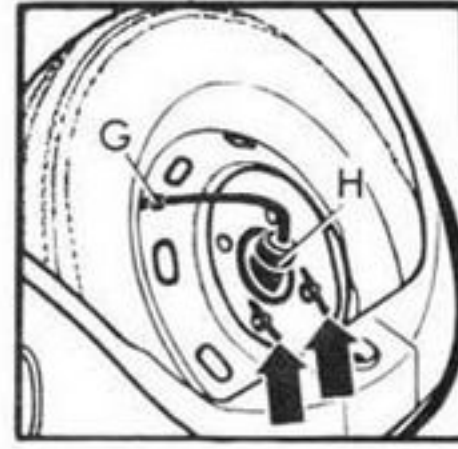

Convertible

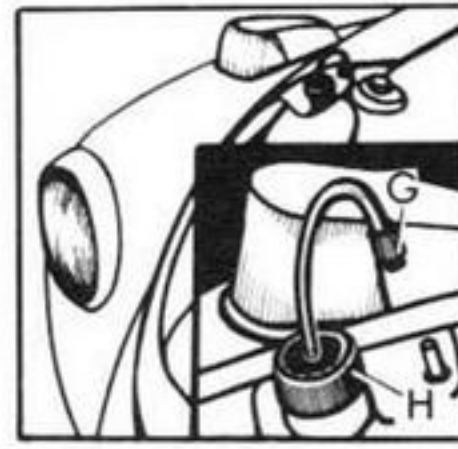

Battery

Under rear seat

Take out rear seat first – see page 47. Check each cell. Top up with distilled water.

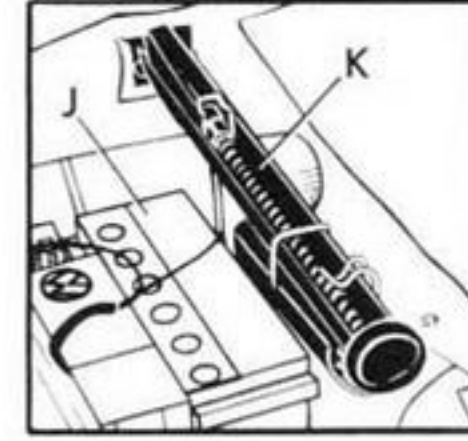

J = Battery

K = Jack

Jack

Under rear seat next to battery

Take out rear seat first – see page 47.

Jack port (L)

Raises entire side for front or rear wheel changing.

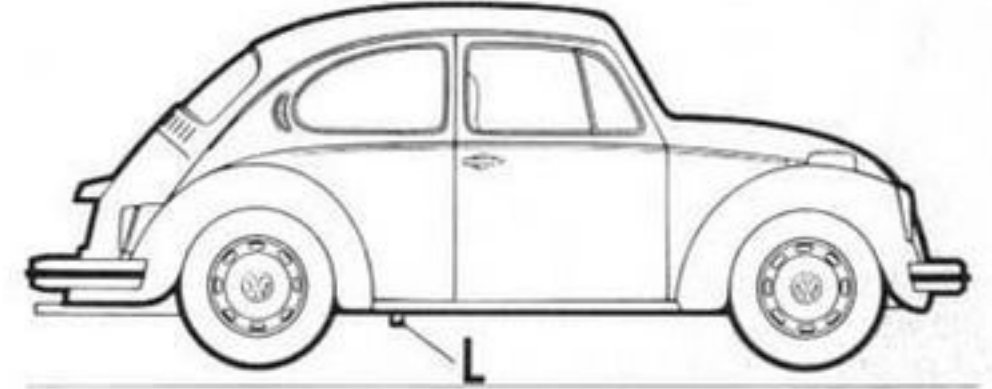

B12-633

© 1976 Volkswagenwerk Aktiengesellschaft

All rights reserved.

May not be reproduced or translated in whole or in part without the written consent of Volkswagenwerk AG.

Specifications subject to alteration without notice.

68 0.00.561.055.23

Printed in Germany 8.76

USA Type 1